SAMSUNG

Outdoor Product User Manual

Model Name: XA067T/XA100T/XA160T

Model Code: LH067XATSAC/**

LH100XATSAC/ LH160XATSAC/****

Version Number: A03

Data: 03-Jun-2020

Table of contents

1. Safety	4
1.1 Warning& Symbols.....	4
1.2 Safety Guidelines	5
1.3 Installation instructions.....	6
2. Open Package	7
2.1 Front view	7
2.2 Side view	8
2.3 Placing cabinet.....	9
3. Outdoor Product introduction.....	10
3.1 Product Specification	10
3.2 Product Appearance.....	16
3.3 Product design	18
3.4 Product main components.....	20
4. LED display screen components	21
5. Parts List And Parts BOM List	23
5.1 Accessories list.....	23
5.2 Spares list	24
5.3 Parts BOM List	25
5.4 Service BOM List	26
6. Trouble shooting list.....	35
6.1 Display screen problem	35
6.2 Cabinet problem	38
6.3 Module problem	40
7. Installation Guides	44
7.1 Mechanical requirements and installation.....	44
7.2 Electrical requirements.....	48
8. Connection of the LED screen	51
8.1 Connection for equipments	51
8.2 Port of Cabinet.....	51
8.3 Connection for power cables	52
8.4 Connection for data cables	53
8.5 Cabinet arrangement drawings sample	54
9. Control system setting.....	55
9.1 Software setup.....	55
9.2 NovaLCT Main interface	56
9.3 Main Menu.....	57
9.4 Screen Config.....	60
9.5 Advanced color configuration	66
9.6 Adjust the brightness and Gamma	69
9.7 Screen Control	74
9.8 Check Hardware Information.....	75
9.9 Brightness/Color Calibration.....	76

9.10 Hardware Monitoring	95
10. Servicing	102
10.1 Cleaning	102
10.2 Calibration	103
10.3 Replacement steps	104
11. Appendix	117
11.1 Responsibility for the Pay Service(Cost to Customers)	117
11.2 Recycle Mark	118

1. Safety

1.1 Warning & Symbols

Grounding

The combination of multiple cabinets in an installation results in increased levels of leakage current. In order to avoid risk of electric shock due to high leakage current, proper grounding of the installation is required.

Defeating the purpose of the grounding type plug will expose you to the risk of electric shock.



Grounding symbols

Electric safety

Do not open equipments with below symbols. To reduce the risk of electric shock, do not remove cover (or back). No user-serviceable parts inside. Qualified service personnel is required for serving.



High voltage symbols



High voltage symbols

The lightning flash with an arrowhead within a triangle is intended to tell the user that parts inside this product may cause a risk of electrical shock to persons.

1.2 Safety Guidelines

Personal protection

Ensure you understand and follow all the safety guidelines, installation instruction, warnings and symbols.

Mind yourself while working with heavy loads and high voltage.

Contact with high voltage may cause death or serious injury. Always disconnect power to the display cabinet or cabinets prior to servicing.

All personnel at the LED Video Board installation site are required to have personal protection equipment (PPE) such as hard hats, safety glasses, gloves, harnesses, and other appropriate safety equipment.

Equipment protection

This installation must be performed by authorized and qualified technical personnel only. Accredited safety officers must ensure the safety of the site, construction, assembly, connection, use, dismantling, transport etc.

Assembly parts are designed for use only with Samsung displays.

LEDs use specific materials and manufacturing processing in order to achieve unique advantages. Do not modify and/or replicate any components.

Ground the LED display screen before connecting the power source. Contacting displays that are not earth-grounded may cause death or serious injury.

Do not use the LED display screen ground lugs for installation equipment such as welding equipment.

Structural & mounting components should be kept dry, clean, lubricated (only if recommended), coated properly, and maintained in a manner consistent with part design. LED products must be installed and operated in a manner to reply on its design and inspection a routine basis for security, wear, deformation, corrosion and any other circumstances that may affect the load handling capability of the part.

We recommend inspections at regular intervals for all installations and increasing in frequency for more critical installations. A part is damaged which may cause a decrease in load capability. The part must be removed for service or replaced immediately.

Always follow LED display screen installation instruction.

Contact the support technical person if user has any question regarding the safety of an application. The manufacturer assumes no liability for incorrect, inadequate, irresponsible or unsafe assembly of systems.

1.3 Installation instructions

Instructions

Read these instructions.

Keep these instructions.

Heed all warnings.

Follow all instructions.

Do not block ventilation openings. Please install in accordance with the manufactures instructions.

Avoid installation near heat sources such as radiators, heat registers, stoves, or other apparatus (including amplifiers) that produce heat. We suggest the user install some equipment to reduce the heat if any.

Do not break the safety purpose of polarized or grounding type plugs/sockets. If the provided sockets/plugs are damaged then replacement of the detective parts must be undertaken immediately.

Protect the power/data cords from being taken off or pinched particularly at plugs, convenience receptacles, and the point where they exit from the apparatus. Replace damaged power/data cords immediately.

Only use attachments/accessories specified or provided by the manufacturer.

Use with caution during lifting/moving or transporting to avoid damage by possible crash.

After receiving the LED display screen, please uncover all the boxes and cases, count and check all things compare with the packing list. If there is any problem such as missing or damaged part, contact the manufacture immediately.

Installation guide details are shown in charter 7&8.

2. Open Package

2.1 Front view

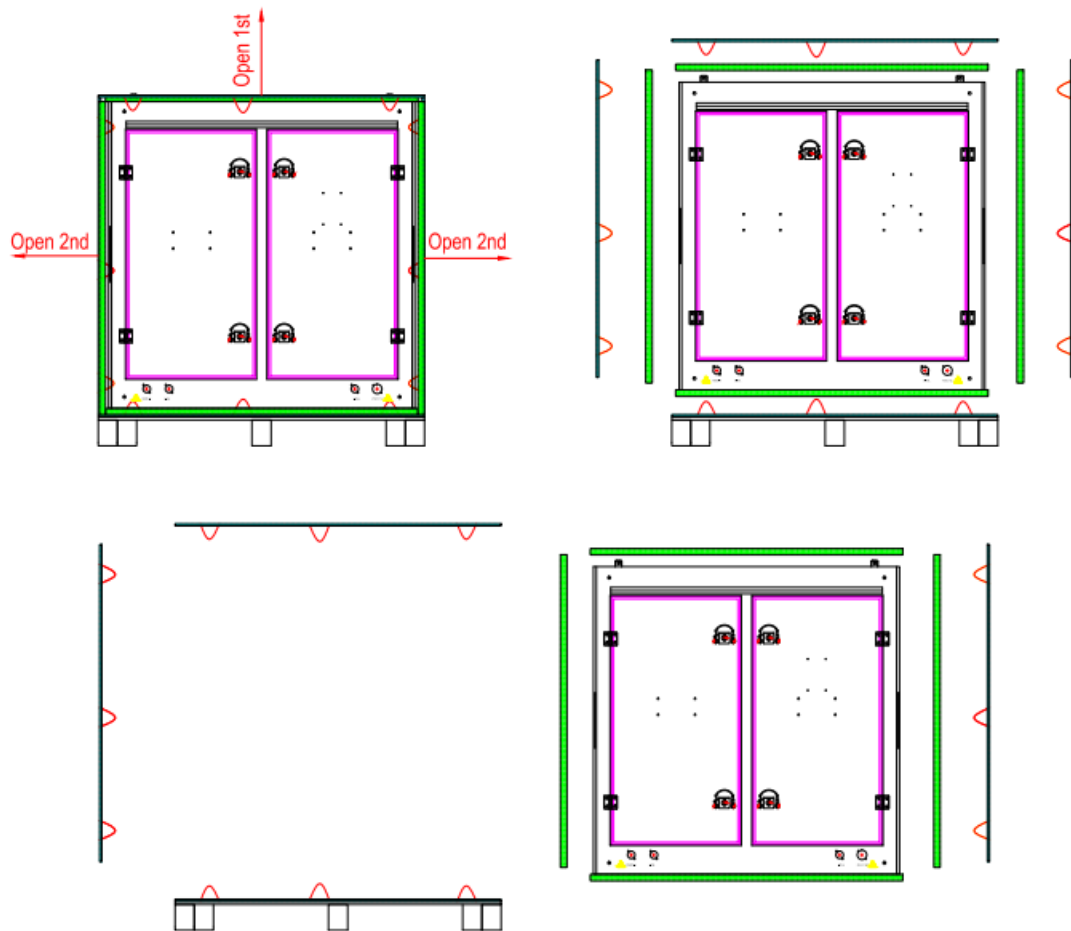

- Step 1: Open the top wooden cover
- Step 2: Open the side wooden cover
- Step 3: Take the cabinet out from the wooden box.

2.2 Side view

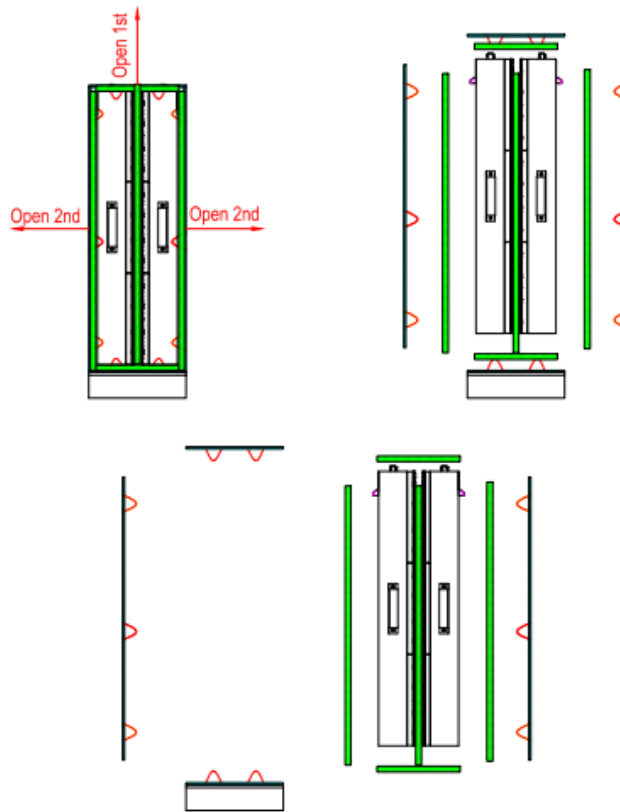

- Step 1: Open the top wooden cover
- Step 2: Open the side wooden cover
- Step 3: Take the cabinet out from the wooden box.

2.3 Placing cabinet

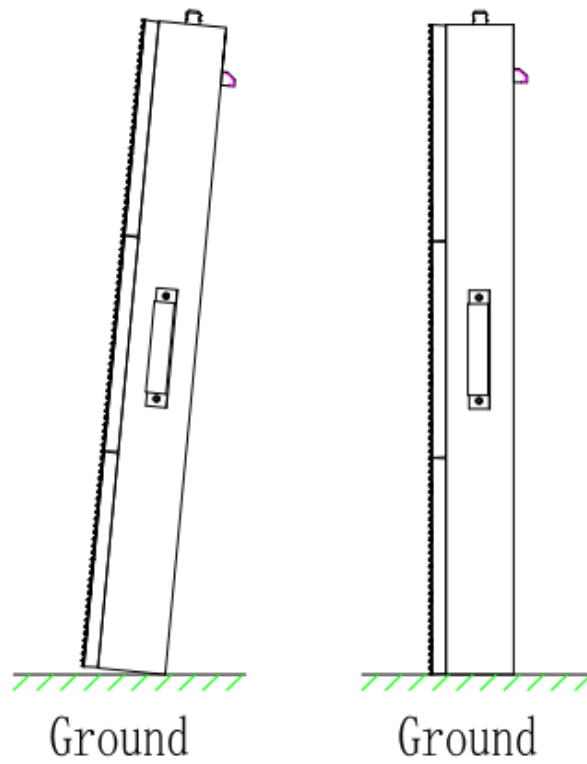

After taking the cabinets out from the wooden box, when you place the cabinet on the ground, please put the back side on the ground first, then carefully put it standing on the ground as shown above to make sure the modules will not be damaged.

3. Outdoor Product introduction

3.1 Product Specification

XAT6.7

No.	Parameter	Specification
1	Attribute	Outdoor P6.7
2	Model Name (VD Common)	XA067T
3	Basic Model Name)	LH067XATSAC
4	Pixel Pitch (mm)	6.7
5	LED vendor	Nationstar
6	LED package type	SMD2727
7	LED package part name	FM-Z2727RGBA-SH
8	LED Lifetime Hr (24Hr, Luminance 50% down)	100,000
9	Size of LED color bin combination	R: 5nm, G:4nm, B:4nm
10	Number of LED color bin combination	1ea, upto 2ea
11	Driver IC vendor	MBI
12	Driver IC part name	MBI5051B
13	T-CON vendor	Novastar
14	T-CON part name	MCTRL600/A4S
15	SMPS vendor	Great Wall
16	SMPS part name	GW-XSP300WV4.5 4.5V/60A
17	Module Dimentions, LxH (mm)	320x320
18	Cabinet Dimensions, LxH (mm)	960x960X125
19	Cabinet Dimensions With Waterproof cover ,LxH (mm)	960x960x149.5
20	Cabinet Weight (kg/cabinet)	32±5%
21	Cabinet Construction	Aluminum
22	Box Dimension ,LxHxD(mm)	1032x1155x390(2pcs in 1 box)
23	Box Volume (m ³)	0.465
24	Package Weight(kg)	93kg (1 box w/ 2 cabinets)
25	Brightness (cd/m ²) Before Calibration	>6700
26	Brightness (cd/m ²) After Calibration	>6000
27	Contrast Ratio(C/R)	3000: 1
28	Front Mask for C/R	Louver/Mask
29	Viewing angle - Horizontal (°)	140
30	Viewing angle - Vertical (°)	100
31	Bit-depth(bit)	14

32	Refresh rate(hz) (typical)	≥ 4000
33	Scan rate (lines)	4
34	Power consumption - Max	$<780(W/m^2) / 72.5 (W/ft^2)$
35	Power consumption - Typical	$<280(W/m^2) / 26.0 (W/ft^2)$
36	Power	AC100-120V/220-240, 47-63Hz
37	Monitoring Function	Temperature and Receiving card
38	Working Temperature (°C)	-30°C to 50°C
39	Operation Humidity	10% to 90%
40	Storage Temperature	-30°C to 60°C
41	Storage Humidity	10% to 90%
42	Color Temperature	
43	- Default	6500K \pm 500K
44	-Adjustable range	2800~16000K
45	Cooling	Self
46	Radian Support	-10° to +90°
47	IP Rating	IP65
48	Accessory in Box	Module, Sending box, Receiving card, Hub boards, SMPS, screws, cables, and so on.
49	EMC Class	Class A
50	Certification	
51	Service	Front and Back service
52	Heat Power Consumption per Cabinets (W)	1564
53	Required Air Flow (CFM)	76
54	Power chain for per input(Pcs)	2 (110V) / 5(220V)
55	Singal chain for per port(Pcs)	30
56	Space for Back service (Behind cabinet)	$\geq 600mm$
57	Space for Front service (Behind cabinet)	$\geq 250mm$

XAT10

No.	Parameter	Specification
1	Attribute	Outdoor P10
2	Model Name (VD Common)	XA100T
3	Basic Model Name)	LH100XATSAC
4	Pixel Pitch (mm)	10
5	LED vendor	Nationstar
6	LED package type	SMD2727
7	LED package part name	FM-Z2727RGBA-SH
8	LED Lifetime Hr (24Hr, Luminance 50% down)	100,000
9	Size of LED color bin combination	R: 5nm, G:4nm, B:4nm
10	Number of LED color bin combination	1ea, upto 2ea
11	Driver IC vendor	MBI
12	Driver IC part name	MBI5051B
13	T-CON vendor	Novastar
14	T-CON part name	MCTRL600/A4S
15	SMPS vendor	Great Wall
16	SMPS part name	GW-XSP300WV4.5 4.5V/60A
17	Module Dimentions, LxH (mm)	320x320
18	Cabinet Dimensions, LxH (mm)	960x960X125
19	Cabinet Dimensions With Waterproof cover ,LxH (mm)	960x960x149.5
20	Cabinet Weight (kg/cabinet)	32±5%
21	Cabinet Construction	Aluminum
22	Box Dimension ,LxHxD(mm)	1032x1155x390(2pcs in 1 box)
23	Box Volume (m ³)	0.465
24	Package Weight(kg)	93kg(1 box w/ 2 cabinets)
25	Brightness (cd/m ²) Before Calibration	>6700
26	Brightness (cd/m ²) After Calibration	>6000
27	Contrast Ratio(C/R)	3000: 1
28	Front Mask for C/R	Louver/Mask
29	Viewing angle - Horizontal (°)	140
30	Viewing angle - Vertical (°)	100
31	Bit-depth(bit)	14
32	Refresh rate(hz) (typical)	≧ 4000
33	Scan rate (lines)	2
34	Power consumption - Max	<780(W/m ²) /72.5 (W/ft ²)
35	Power consumption - Typical	<280(W/m ²) /26.0 (W/ft ²)

36	Power	AC100-120V/220-240, 47-63Hz
37	Monitoring Function	Temperature and Receiving card
38	Working Temperature (°C)	-30°C to 50°C
39	Operation Humidity	10% to 90%
40	Storage Temperature	-30°C to 60°C
41	Storage Humidity	10% to 90%
42	Color Temperature	
43	- Default	6500K±500K
44	-Adjustable range	2800~16000K
45	Cooling	Self
46	Radian Support	-10° to +90°
47	IP Rating	IP65
48	Accessory in Box	Module, Sending box, Receiving card, Hub boards, SMPS, screws, cables, and so on.
49	EMC Class	Class A
50	Certification	
51	Service	Front and Back service
52	Heat Power Consumption per Cabinets (W)	1535
53	Required Air Flow (CFM)	74.7
54	Power chain for per input(Pcs)	2 (110V) / 5(220V)
55	Singal chain for per port(Pcs)	60
56	Space for Back service (Behind cabinet)	≧ 600mm
57	Space for Front service (Behind cabinet)	≧ 250mm

XAT16

No.	Parameter	Specification
1	Attribute	Outdoor P16
2	Model Name (VD Common)	XA160T
3	Basic Model Name)	LH160XATSAC
4	Pixel Pitch (mm)	16
5	LED vendor	Retop
6	LED package type	DIP346
7	LED package part name	Retop346
8	LED Lifetime Hr (24Hr, Luminance 50% down)	100,000
9	Size of LED color bin combination	R: 2nm, G:2nm, B:2nm
10	Number of LED color bin combination	1ea, upto 2ea
11	Driver IC vendor	MBI
12	Driver IC part name	MBI5124
13	T-CON vendor	Novastar
14	T-CON part name	MCTRL600/A4S
15	SMPS vendor	Great Wall
16	SMPS part name	GW-XSP300WV4.5 4.5V/60A
17	Module Dimentions, LxH (mm)	320x320
18	Cabinet Dimensions, LxH (mm)	960x960X135
19	Cabinet Dimensions With Waterproof cover ,LxH (mm)	960x960x159.5
20	Cabinet Weight (kg/cabinet)	37±5%
21	Cabinet Construction	Aluminum
22	Box Dimension ,LxHxD(mm)	1032x1155x390(2pcs in 1 box)
23	Box Volume (m ³)	0.465
24	Package Weight(kg)	103kg(1 box w/ 2 cabinets)
25	Brightness (cd/m ²) Before Calibration	>8100
26	Brightness (cd/m ²) After Calibration	>7300
27	Contrast Ratio(C/R)	3000: 1
28	Front Mask for C/R	Louver/Mask
29	Viewing angle - Horizontal (°)	120
30	Viewing angle - Vertical (°)	60
31	Bit-depth(bit)	14
32	Refresh rate(hz) (typical)	≧ 1920
33	Scan rate (lines)	1
34	Power consumption - Max	<600(W/m ²) /55.8 (W/ft2)
35	Power consumption - Typical	<210(W/m ²) /19.5 (W/ft2)
36	Power	AC100-120V/220-240, 47-63Hz

37	Monitoring Function	Temperature and Receiving card
38	Working Temperature (°C)	-30°C to 50°C
39	Operation Humidity	10% to 90%
40	Storage Temperature	-30°C to 60°C
41	Storage Humidity	10% to 90%
42	Color Temperature	
43	- Default	6500K±500K
44	-Adjustable range	2800~16000K
45	Cooling	Self
46	Radian Support	-10° to +90°
47	IP Rating	IP65
48	Accessory in Box	Module, Sending box, Receiving card, Hub boards, SMPS, screws, cables, and so on.
49	EMC Class	Class A
50	Certification	
51	Service	Front and Back service
52	Heat Power Consumption per Cabinets (W)	518
53	Required Air Flow (CFM)	25.1
54	Power chain for per input(Pcs)	3 (110V) / 6(220V)
55	Singal chain for per port(Pcs)	160
56	Space for Back service (Behind cabinet)	≧ 600mm
57	Space for Front service (Behind cabinet)	≧ 250mm

3.2 Product Appearance

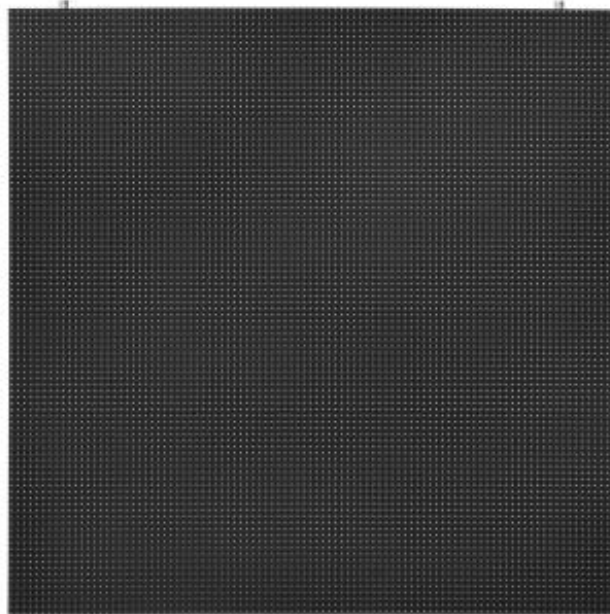
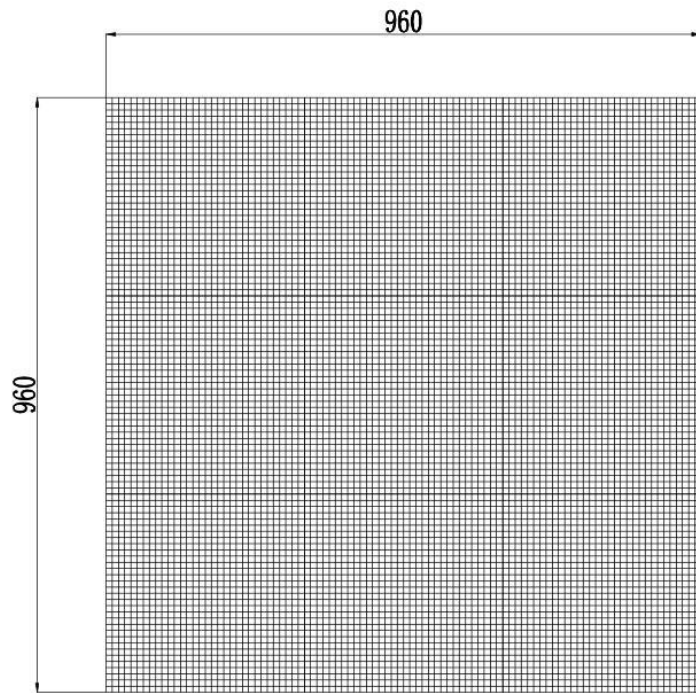

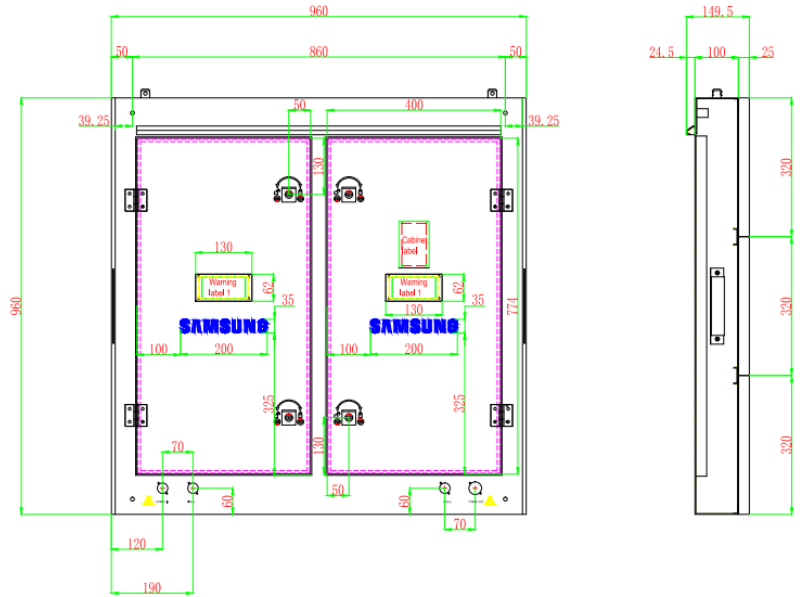

XAT6.7&XAT10

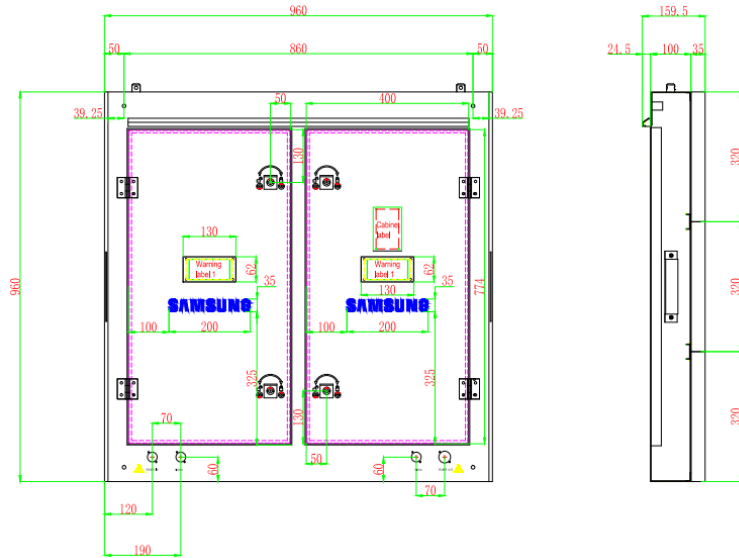

XAT16



3.3 Product design

Decomposition chart

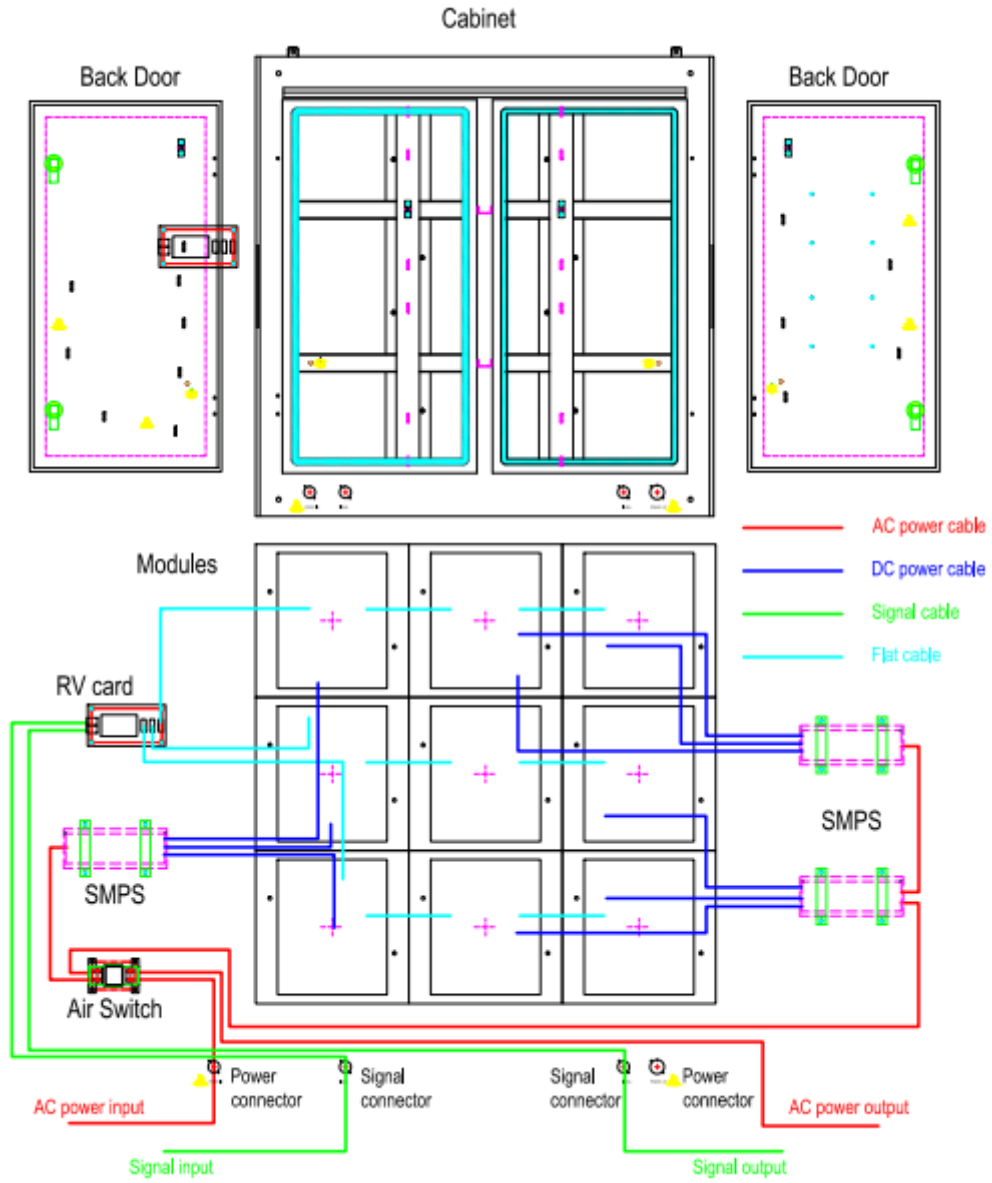

Assembly drawing

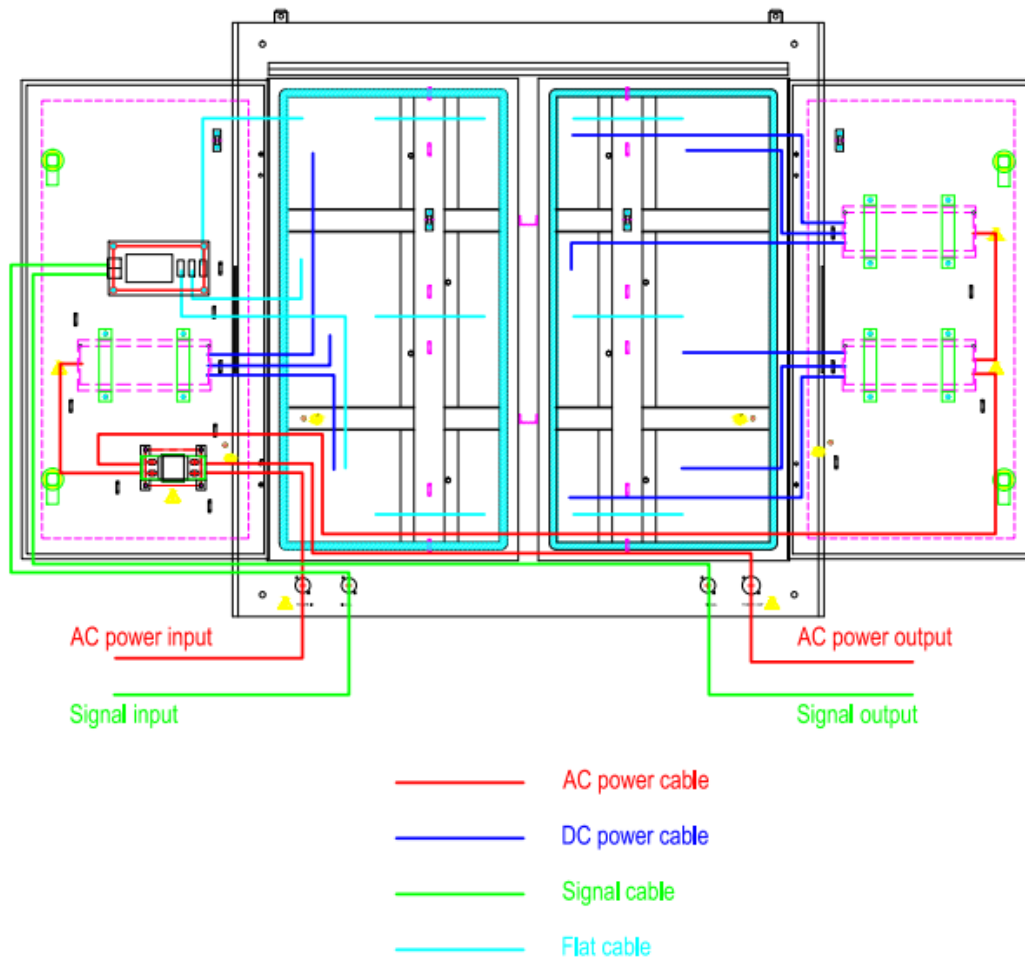

3.4 Product main components

Module

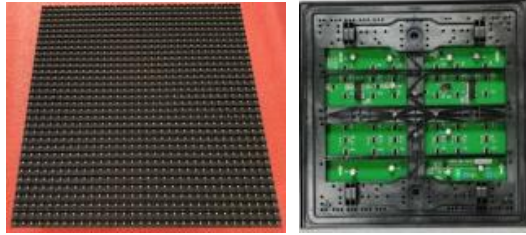

Power Supply



Receiving card

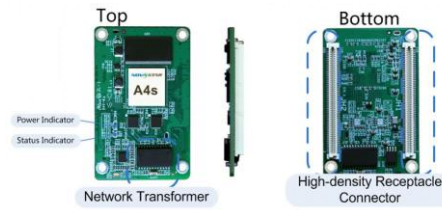

DC output cables (9 pcs)



Flat cables (9 pcs)



4. LED display screen components

LED display screen connection

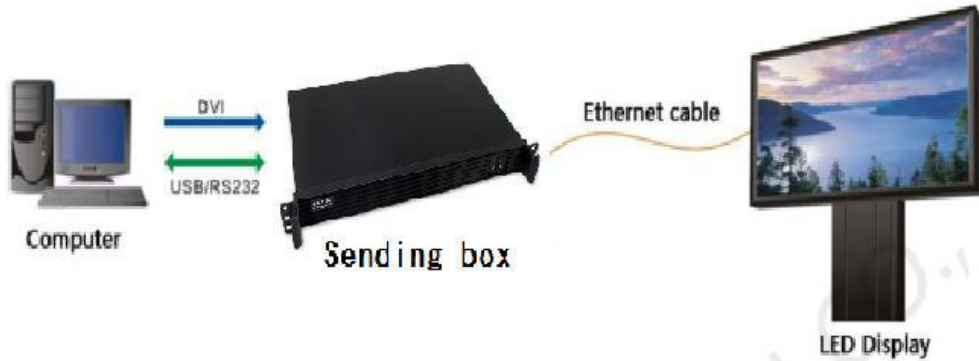

Sending box(Model Name:LSFNS, Model Code: VG-LSFNS)

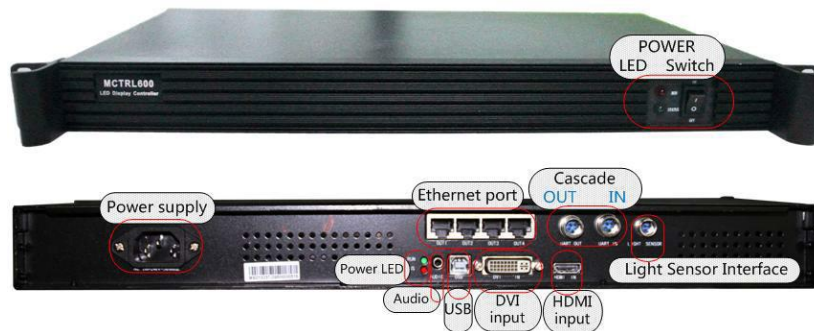

Power LED and Switch:

Power on or power off the sending box, the LED show the status of sending box.

Power supply:

AC power input, offer power for sending box.

Power LED on back:

Show the status of sending card.

Audio:

Audio input, connect to the audio source, receiving the audio signal

USB:

Control port, connect to the computer, receiving control signal

DVI input:

DVI video input, connect to the video source, receiving the video signal

HDMI input:

HDMI video input, connect to the video source, receiving the video signal

Ethernet port:

Signal output ports, connect to the display, pass signal

Cascade:

Cascade control in and out, connect to another sending box

Light Sensor interface:

Connect to the light sensor, support brightness adjustment automatically.

Function of sending box:

1. HDMI/DVI input;
 2. HDMI/external audio input;
 3. 12bit/10bit/8bit HD video source;
 4. Resolution supported: 2048x1152, 1920x1200, 2560x960;
 5. Resolution supported: 1440x900;
 6. 1 light sensor interface;
 7. Cascading supported;
 8. 18bit gray scale processing and presentation;
 9. Video format:RGB, YCrCb4:2:2, YCrCb4:4:4;
 10. Standard 1U housing; independent power supply;
- 1U chassis, Size: 482.6mm(width)*44.45mm(height)*250mm(depth).dd Weight: 4.15Kg
Net weight: 2.7Kg

Computer



Note: Usually the sending box and he PC should be running in control room.

LED display screen



5. Parts List And Parts BOM List

5.1 Accessories list



Sending box
BN81-15303A
R2S8-22-1721



U Disk
2S8-22-10025



3 core plug
BN81-15312A
R2J8-22-0125



DVI cable
BN81-15310A
R2L3-27-0104



USB cable
BN81-15311A
R2L3-27-0105



AC power input cable
Different code by different project
Different code by different project



Signal input cable



AC power cascade cable
3D2-22-10363



Signal cascade cable
3D3-23-10101



Connect plate
BN81-15326A
R2J8-42-0072



M10 Bolts
BN81-15334A
R2W8-22-0466



Key for back door
BN81-15335A
R2W8-29-3277

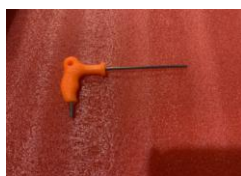

Tool for service (Front)

R2W8-29-2868



Service wire for door

R2W8-29-10213

Remark: The final quantity is subject to each order.

5.2 Spares list



Sending box
BN81-15303A

R2S8-22-1721



Receiving card and HUB board

R2S8-22-1761(R3C6-88-10053)



Module

R4B3-10-10013



Power supply

R2D8-25-10006



LED package

R3G1-27-0048



Driver IC

BN81-15332A

R2K2-22-0219

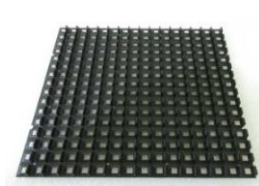

Mask

R2A8-24-10024



Screws for Mask

BN81-15336A

R2W8-22-1410



Tool for service (Front)

R2W8-29-2868



AC power input cable

Different code by different project

Different code by different project



Signal input cable



AC power cascade cable

3D2-22-10363



Signal cascade cable

3D3-23-10101

Other materials



DC output cable

3D2-22-8474(...)



Flat cables

3D4-23-10040(...)



Service wire for door

R2W8-29-10213

Remark: The final quantity is subject to each order. 3% spare parts will be sent within each order.





















5.3 Parts BOM List











Code	Name	Spec	Unit	Quantity
R2S8-22-1721	Sending box	MCTRL600-S (ROHS)	PCS	Depend on project
R2W8-27-10392	Outdoor Cabinet	960*960*100mm	PCS	
R4B3-10-10013	P10 module	32X32 EMC Nova system(ROHS)	PCS	
R2J8-22-0125	3 core plug	L 1.5M	PCS	
2S8-22-10025	U Disk	Control software/Setting files	PCS	
R2L3-27-0104	DVI cable	L 1.5M	PCS	
R2L3-27-0105	USB cable	L 1.5M	PCS	
R2S8-22-1761	Receiving card	A4S (ROHS)	PCS	
R3C6-88-10053	Hub Board	Hub for XAT	PCS	
Depend on project	Signal input cable	Cat-5 type L (depend on project)	PCS	
Depend on project	AC power input cable	3*2.5m m ² L(depend on project)	PCS	
3D2-22-10363	AC Power cascade cable	3*2.5m m ² 50CM,two end connectors	PCS	
3D3-23-10101	Signal cascade cable	Cat-5 type 60CM,two end connectors	PCS	
R2J8-42-0200	Connect plate	130*100*4.0mm (ROHS)	PCS	
R2J8-42-2403	Connect plate	130*50*4.0mm (ROHS)	PCS	
R2W8-22-0466	M10 Bowls	Six angle (stainless steel) (ROHS)	PCS	
R2W8-29-3277	Key for back door	Circle with ears	PCS	
R2D8-25-10006	Power supply	GW-XSP300WV4.5 / 5V/60A	PCS	
R2S9-88-0298	Air switch	NDB2-63-D10(ROHS)	PCS	
R3G1-27-0048	LED package	Nation Star 2727 (M-Z2727RGBA-SH)	PCS	
R2K2-22-0219	Driver IC	MBI5051B GP MSSOP24L-150-0.635	PCS	
R2A8-24-10024	Mask	Mask P10(16*16) H-5mm ROHS	PCS	
R2W8-22-1410	Screws for Mask	Black (φ2.8) ROHS	PCS	
3D2-22-8474(...)	DC output cable	2.5m m ² 2.5-40,6P3.96 80CM (UL)...	PCS	
3D4-23-10040(...)	Flat cables	20P 20CM(UL)...	PCS	

5.4 Service BOM List

XAT 6.7 SVC BOM





















Item	Spec	Code.No	SAMSUNG Spec	Photo	Quantity	Unit
LED MOUDLE	Module (P6.7 48*48 4S)	R4B3-06-10012	A/S-LED MOUDLE:JDM, R4B3-06-10012 ,Module (P6.7 48*48 4S)		9	PCS
LED	LED (FM-Z2727RGBA-SH)	R3G1-27-0048	A/S-LED:JDM, R3G1-27-0048 ,LED (FM-Z2727RGBA-SH)		2304	PCS
DRIVER IC	IC (MBI5051B)	R2K2-22-0219	A/S-DRIVER IC:JDM, R2K2-22-0219 ,IC (MBI5051B)		108	PCS
MASK	Mask	R2A8-24-10015	A/S-MASK:JDM, R2A8-24-10015 ,Mask		4	PCS
SENDING BOX	Sending box (MCTRL600-S)	R2S8-22-1721	A/S-SENDING BOX:JDM, R2S8-22-1721 ,Sending box (MCTRL600-S)		1	PCS
POWER SUPPLY	SMPS (GW-XSP300WV4.5 / 5V/60A)	R2D8-25-10006	A/S-POWER SUPPLY:JDM, R2D8-25-10006 ,GW-XSP300WV4.5 / 5V/60A		3	PCS
RECEIVING CARD	Receiving card (A4S)	R2S8-22-1761	A/S-RECEIVING CARD:JDM, R2S8-22-1761 ,A4S		1	PCS
HUB BOARD	HUB BOARD	R3C6-88-10053	A/S-HUB BOARD:JDM, R3C6-88-10053 ,Hub for XAT		1	PCS
AIR SWITCH	Air switch	R2S9-88-0298	A/S-AIR SWITCH:JDM, R2S9-88-0298 ,NDB2-63-D10(ROHS)		1	PCS
DVI CABLE	DVI Cable	R2L3-27-0104	A/S-DVI CABLE:JDM, R2L3-27-0104 ,DVI Cable		1	PCS
USB CABLE	USB Cable	R2L3-27-0105	A/S-USB CABLE:JDM, R2L3-27-0105 ,USB Cable		1	PCS
POWER CORD	3 core plug (VDE)	R2J8-22-0125	A/S-POWER CORD:JDM, R2J8-22-0125 ,3 core plug		1	PCS
AC POWER CABLE	AC power cascade cable (3*2.5m 150CM)	3D2-22-10382	A/S-AC POWER CABLE:JDM, 3D2-22-10382 ,3*2.5m 150CM		1	PCS
AC POWER CABLE	AC power cascade cable (3*2.5m 50CM)	3D2-22-10363	A/S-AC POWER CABLE:JDM, 3D2-22-10363 ,3*2.5m 50CM		1	PCS
LAN CABLE	Signal cascade cable (120CM Cat-5)	3D3-23-10102	A/S-AC POWER CABLE:JDM, 3D3-23-10102 ,120CM Cat-5		1	PCS
LAN CABLE	Signal cascade cable (60CM Cat-5)	3D3-23-10101	A/S-AC POWER CABLE:JDM, 3D3-23-10101 ,60CM Cat-5		1	PCS
AC CABLE	AC power cable(With connect)	3D2-22-10358	A/S-AC CABLE:JDM, 3D2-22-10358 ,2.5m 35CM Seetronic-SAC3MPX		1	PCS









AC CABLE	AC power cable(With connect)	3D2-22-10359	A/S-AC CABLE:JDM, 3D2-22-10359 ,2.5m m ² 110CM Seetronic-SAC3FPX		1	PCS
AC CABLE	AC power cable(No connect)	3D2-22-10355	A/S-AC CABLE:JDM, 3D2-22-10355 ,1.0m m ² 175CM,2.5-40		1	PCS
AC CABLE	AC power cable(No connect)	3D2-22-10356	A/S-AC CABLE:JDM, 3D2-22-10356 ,1.0m m ² 30CM,2.5-40		1	PCS
AC CABLE	AC power cable(No connect)	3D2-22-10357	A/S-AC CABLE:JDM, 3D2-22-10357 ,1.0m m ² 30CM,2.5-40,2.5-40		1	PCS
SIGNAL CABLE	Signal cable	3D2-23-8025	A/S-SIGNAL CABLE:JDM, 3D2-23-8025 ,100CM Cat-5,two end network		1	PCS
SIGNAL CABLE	Signal cable	3D2-23-8001	A/S-SIGNAL CABLE:JDM, 3D2-23-8001 ,150CM Cat-5, two end network		1	PCS
SIGNAL CONNECTOR	Signal connector	R2J8-22-10032	A/S-SIGNAL CONNECTOR:JDM, R2J8-22-10032 , SE8FD05-01/IP65 ROHS		2	PCS
WATER-PROOF COVER	Water-proof cover	R2J8-22-10034	A/S-WATER-PROOF COVER:JDM, R2J8-22-10034 , CNAC-MPX ,match SAC3MPX, ROHS		1	PCS
WATER-PROOF COVER	Water-proof cover	R2J8-22-10035	A/S-WATER-PROOF COVER:JDM, R2J8-22-10035 , CNAC-FPX, match SAC3FPX, ROHS		1	PCS
DC OUTPUT CABLE	DC output cable (2.5m m ² 35CM)	3D2-22-8474	A/S-DC CABLE:JDM, 3D2-22-8474 ,2.5m m ² 35CM		1	PCS
DC OUTPUT CABLE	DC output cable (2.5m m ² 45CM)	3D2-22-10346	A/S-DC CABLE:JDM, 3D2-22-10346 ,2.5m m ² 45CM		2	PCS
DC OUTPUT CABLE	DC output cable (2.5m m ² 50CM)	3D2-22-10347	A/S-DC CABLE:JDM, 3D2-22-10347 ,2.5m m ² 50CM		1	PCS
DC OUTPUT CABLE	DC output cable (2.5m m ² 60CM)	3D2-22-8475	A/S-DC CABLE:JDM, 3D2-22-8475 ,2.5m m ² 60CM		1	PCS
DC OUTPUT CABLE	DC output cable (2.5m m ² 75CM)	3D2-22-10348	A/S-DC CABLE:JDM, 3D2-22-10348 ,2.5m m ² 75CM		1	PCS
DC OUTPUT CABLE	DC output cable (2.5m m ² 80CM)	3D2-22-10349	A/S-DC CABLE:JDM, 3D2-22-10349 ,2.5m m ² 80CM		3	PCS
DC OUTPUT CABLE	DC cable for receiving card(1.0m m ² 30CM)	3D2-22-10354	A/S-DC CABLE:JDM, 3D2-22-10354 ,1.0m m ² 30CM		1	PCS
FLAT CABLE	Flat cable (16P 30CM)	3D4-23-10040	A/S-FLAT CABLE:JDM, 3D4-23-10040 ,Flat cable (16P 30CM)		6	PCS
FLAT CABLE	Flat cable (16P 40CM)	3D4-23-10042	A/S-FLAT CABLE:JDM, 3D4-23-10042 ,Flat cable (16P 40CM)		1	PCS
FLAT CABLE	Flat cable (16P 60CM)	3D4-23-10024	A/S-FLAT CABLE:JDM, 3D4-23-10024 ,Flat cable (16P 60CM)		1	PCS
FLAT CABLE	Flat cable (16P 70CM)	3D4-23-10047	A/S-FLAT CABLE:JDM, 3D4-23-10047 ,Flat cable (16P 70CM)		1	PCS

CONNECT PLATE	Connect plate(130*100*4.0mm)	R2J8-42-0200	A/S-CONNECT PLATE:JDM, R2J8-42-0200 ,Connect plate(130*100*4.0mm)		4	PCS
CONNECT PLATE	Connect plate(130*50*4.0mm)	R2J8-42-2403	A/S-CONNECT PLATE:JDM, R2J8-42-2403 ,Connect plate(130*50*4.0mm)		1	PCS
SERVICE TOOL	Service tool (T type)	R2W8-29-2868	A/S-SERVICE TOOL:JDM, R2W8-29-2868 ,Service tool (T type)		1	PCS
SCREW	Screws (M3*8)	R2W8-22-1355	A/S-SCREW:JDM, R2W8-22-1355 ,Screws (M3*8),Fix SMPS, Air switch		28	PCS
SCREW	Screws (M3*6)	R2W8-22-0050	A/S-SCREW:JDM, R2W8-22-0050 ,Screws (M3*6),Fix receiving card, hub board		4	PCS
U DISK	U DISK	2S8-22-10025	A/S-U DISK:JDM, 2S8-22-10025 ,U DISK		1	PCS
M10 BOWLS	M10 Bowls	R2W8-22-0466	A/S-M10 BOWLS:JDM, R2W8-22-0466 ,M10 Bowls		16	PCS
KEY FOR DOOR	Key for back door	R2W8-29-3277	A/S-KEY FOR DOOR:JDM, R2W8-29-3277 ,Key for back door		1	PCS
SERVICE WIRE	Service wire for door	R2W8-29-10213	A/S-SERVICE WIRE:JDM, R2W8-29-10213 ,Service wire for door		1	PCS
SCREW	Screws for Mask (M1.2*6)	R2W8-22-1410	A/S-SCREW:JDM, R2W8-22-1410 ,Screws for Mask (M1.2*6)		101	PCS

XAT 10 SVC BOM















Item	Spec	Code.No	SAMSUNG Spec	Photo	Quantity	Unit
LED MOUDLE	Module (P10 32*32 2S)	R4B3-10-10013	A/S-LED MOUDLE:JDM, R4B3-10-10013 ,Module (P10 32*32 2S)		9	PCS
LED	LED (FM-Z2727RGBA-SH)	R3G1-27-0048	A/S-LED:JDM, R3G1-27-0048 ,LED (FM-Z2727RGBA-SH)		1024	PCS
DRIVER IC	IC (MBI5051B)	R2K2-22-0219	A/S-DRIVER IC:JDM, R2K2-22-0219 ,IC (MBI5051B)		96	PCS
MASK	Mask	R2A8-24-10024	A/S-MASK:JDM, R2A8-24-10024 ,Mask		4	PCS
SENDING BOX	Sending box (MCTRL600-S)	R2S8-22-1721	A/S-SENDING BOX:JDM, R2S8-22-1721 ,Sending box (MCTRL600-S)		1	PCS
POWER SUPPLY	SMPS (GW-XSP300WV4.5 / 5V/60A)	R2D8-25-10006	A/S-POWER SUPPLY:JDM, R2D8-25-10006 ,GW-XSP300WV4.5 / 5V/60A		3	PCS
RECEIVING CARD	Receiving card (A4S)	R2S8-22-1761	A/S-RECEIVING CARD:JDM, R2S8-22-1761 ,A4S		1	PCS
HUB BOARD	HUB BOARD	R3C6-88-10053	A/S-HUB BOARD:JDM, R3C6-88-10053 ,Hub for XAT		1	PCS
AIR SWITCH	Air switch	R2S9-88-0298	A/S-AIR SWITCH:JDM, R2S9-88-0298 ,NDB2-63-D10(ROHS)		1	PCS
DVI CABLE	DVI Cable	R2L3-27-0104	A/S-DVI CABLE:JDM, R2L3-27-0104 ,DVI Cable		1	PCS
USB CABLE	USB Cable	R2L3-27-0105	A/S-USB CABLE:JDM, R2L3-27-0105 ,USB Cable		1	PCS
POWER CORD	3 core plug (VDE)	R2J8-22-0125	A/S-POWER CORD:JDM, R2J8-22-0125 ,3 core plug		1	PCS
AC POWER CABLE	AC power cascade cable (3*2.5m m^2 150CM)	3D2-22-10382	A/S-AC POWER CABLE:JDM, 3D2-22-10382 ,3*2.5m m^2 150CM		1	PCS
AC POWER CABLE	AC power cascade cable (3*2.5m m^2 50CM)	3D2-22-10363	A/S-AC POWER CABLE:JDM, 3D2-22-10363 ,3*2.5m m^2 50CM		1	PCS
LAN CABLE	Signal cascade cable (120CM Cat-5)	3D3-23-10102	A/S-AC POWER CABLE:JDM, 3D3-23-10102 ,120CM Cat-5		1	PCS
LAN CABLE	Signal cascade cable (60CM Cat-5)	3D3-23-10101	A/S-AC POWER CABLE:JDM, 3D3-23-10101 ,60CM Cat-5		1	PCS
AC CABLE	AC power cable(With connect)	3D2-22-10358	A/S-AC CABLE:JDM, 3D2-22-10358 ,2.5m m^2 35CM Seetronic-SAC3MPX		1	PCS
AC CABLE	AC power cable(With connect)	3D2-22-10359	A/S-AC CABLE:JDM, 3D2-22-10359 ,2.5m m^2 110CM Seetronic-SAC3FPX		1	PCS
AC CABLE	AC power cable(No connect)	3D2-22-10355	A/S-AC CABLE:JDM, 3D2-22-10355 ,1.0m m^2 175CM,2.5-40		1	PCS









AC CABLE	AC power cable(No connect)	3D2-22-10356	A/S-AC CABLE:JDM, 3D2-22-10356 ,1.0m m^2 30CM,2.5-40		1	PCS
AC CABLE	AC power cable(No connect)	3D2-22-10357	A/S-AC CABLE:JDM, 3D2-22-10357 ,1.0m m^2 30CM,2.5-40,2.5-40		1	PCS
SIGNAL CABLE	Signal cable	3D2-23-8025	A/S-SIGNAL CABLE:JDM, 3D2-23-8025 ,100CM Cat-5,two end network		1	PCS
SIGNAL CABLE	Signal cable	3D2-23-8001	A/S-SIGNAL CABLE:JDM, 3D2-23-8001 ,150CM Cat-5, two end network		1	PCS
SIGNAL CONNECTOR	Signal connector	R2J8-22-10032	A/S-SIGNAL CONNECTOR:JDM, R2J8-22-10032 , SE8FD05-01/IP65 ROHS		2	PCS
WATER-PROOF COVER	Water-proof cover	R2J8-22-10034	A/S-WATER-PROOF COVER:JDM, R2J8-22-10034 , CNAC-MPX ,match SAC3MPX, ROHS		1	PCS
WATER-PROOF COVER	Water-proof cover	R2J8-22-10035	A/S-WATER-PROOF COVER:JDM, R2J8-22-10035 , CNAC-FPX, match SAC3FPX, ROHS		1	PCS
DC OUTPUT CABLE	DC output cable (2.5m m^2 35CM)	3D2-22-8474	A/S-DC CABLE:JDM, 3D2-22-8474 ,2.5m m^2 35CM		1	PCS
DC OUTPUT CABLE	DC output cable (2.5m m^2 45CM)	3D2-22-10346	A/S-DC CABLE:JDM, 3D2-22-10346 ,2.5m m^2 45CM		2	PCS
DC OUTPUT CABLE	DC output cable (2.5m m^2 50CM)	3D2-22-10347	A/S-DC CABLE:JDM, 3D2-22-10347 ,2.5m m^2 50CM		1	PCS
DC OUTPUT CABLE	DC output cable (2.5m m^2 60CM)	3D2-22-8475	A/S-DC CABLE:JDM, 3D2-22-8475 ,2.5m m^2 60CM		1	PCS
DC OUTPUT CABLE	DC output cable (2.5m m^2 75CM)	3D2-22-10348	A/S-DC CABLE:JDM, 3D2-22-10348 ,2.5m m^2 75CM		1	PCS
DC OUTPUT CABLE	DC output cable (2.5m m^2 80CM)	3D2-22-10349	A/S-DC CABLE:JDM, 3D2-22-10349 ,2.5m m^2 80CM		3	PCS
DC OUTPUT CABLE	DC cable for receiving card(1.0m m^2 30CM)	3D2-22-10354	A/S-DC CABLE:JDM, 3D2-22-10354 ,1.0m m^2 30CM		1	PCS
FLAT CABLE	Flat cable (16P 30CM)	3D4-23-10040	A/S-FLAT CABLE:JDM, 3D4-23-10040 ,Flat cable (16P 30CM)		6	PCS
FLAT CABLE	Flat cable (16P 40CM)	3D4-23-10042	A/S-FLAT CABLE:JDM, 3D4-23-10042 ,Flat cable (16P 40CM)		1	PCS
FLAT CABLE	Flat cable (16P 60CM)	3D4-23-10024	A/S-FLAT CABLE:JDM, 3D4-23-10024 ,Flat cable (16P 60CM)		1	PCS
FLAT CABLE	Flat cable (16P 70CM)	3D4-23-10047	A/S-FLAT CABLE:JDM, 3D4-23-10047 ,Flat cable (16P 70CM)		1	PCS
CONNECT PLATE	Connect plate(130*100*4.0mm)	R2J8-42-0200	A/S-CONNECT PLATE:JDM, R2J8-42-0200 ,Connect plate(130*100*4.0mm)		4	PCS
CONNECT PLATE	Connect plate(130*50*4.0mm)	R2J8-42-2403	A/S-CONNECT PLATE:JDM, R2J8-42-2403 ,Connect plate(130*50*4.0mm)		1	PCS

SERVICE TOOL	Service tool (T type)	R2W8-29-2868	A/S-SERVICE TOOL:JDM, R2W8-29-2868 ,Service tool (T type)		1	PCS
SCREW	Screws (M3*8)	R2W8-22-1355	A/S-SCREW:JDM, R2W8-22-1355 ,Screws (M3*8),Fix SMPS, Air switch		28	PCS
SCREW	Screws (M3*6)	R2W8-22-0050	A/S-SCREW:JDM, R2W8-22-0050 ,Screws (M3*6),Fix receiving card, hub board		4	PCS
U DISK	U DISK	2S8-22-10025	A/S-U DISK:JDM, 2S8-22-10025 ,U DISK		1	PCS
M10 BOWLS	M10 Bowls	R2W8-22-0466	A/S-M10 BOWLS:JDM, R2W8-22-0466 ,M10 Bowls		16	PCS
KEY FOR DOOR	Key for back door	R2W8-29-3277	A/S-KEY FOR DOOR:JDM, R2W8-29-3277 ,Key for back door		1	PCS
SERVICE WIRE	Service wire for door	R2W8-29-10213	A/S-SERVICE WIRE:JDM, R2W8-29-10213 ,Service wire for door		1	PCS
SCREW	Screws for Mask (M1.2*6)	R2W8-22-1410	A/S-SCREW:JDM, R2W8-22-1410 ,Screws for Mask (M1.2*6)		101	PCS

XAT 16 SVC BOM

Item	Spec	Code.No	SAMSUNG Spec	Photo	Quantity	Unit
LED MOUDLE	Module (P16 20*20 1S)	R4B3-16-10004	A/S-LED MOUDLE:JDM, R4B3-16-10004 ,Module (P16 20*20 1S)		9	PCS
LED	LED R (DIP346-K2)	R3G3-22-10002	A/S-LED:JDM, R3G3-22-10002 ,LED R (DIP346-K2)		400	PCS
	LED G (DIP346-K2)	R3G3-23-10001	A/S-LED:JDM, R3G3-23-10001 ,LED G (DIP346-K2)		400	PCS
	LED B (DIP346-K2)	R3G3-24-10001	A/S-LED:JDM, R3G3-24-10001 ,LED B (DIP346-K2)		400	PCS
DRIVER IC	IC (MBI5124)	R2K2-22-10000	A/S-DRIVER IC:JDM, R2K2-22-10000 ,IC (MBI5124)		75	PCS
MASK	Mask	R2A8-24-10028	A/S-MASK:JDM, R2A8-24-10028 ,Mask		2	PCS
SENDING BOX	Sending box (MCTRL600-S)	R2S8-22-1721	A/S-SENDING BOX:JDM, R2S8-22-1721 ,Sending box (MCTRL600-S)		1	PCS
POWER SUPPLY	SMPS (GW-XSP300WV4.5 / 5V/60A)	R2D8-25-10006	A/S-POWER SUPPLY:JDM, R2D8-25-10006 ,GW-XSP300WV4.5 / 5V/60A		3	PCS
RECEIVING CARD	Receiving card (A4S)	R2S8-22-1761	A/S-RECEIVING CARD:JDM, R2S8-22-1761 ,A4S		1	PCS
HUB BOARD	HUB BOARD	R3C6-88-10053	A/S-HUB BOARD:JDM, R3C6-88-10053 ,Hub for XAT		1	PCS
AIR SWITCH	Air switch	R2S9-88-0298	A/S-AIR SWITCH:JDM, R2S9-88-0298 ,NDB2-63-D10(ROHS)		1	PCS
DVI CABLE	DVI Cable	R2L3-27-0104	A/S-DVI CABLE:JDM, R2L3-27-0104 ,DVI Cable		1	PCS
USB CABLE	USB Cable	R2L3-27-0105	A/S-USB CABLE:JDM, R2L3-27-0105 ,USB Cable		1	PCS
POWER CORD	3 core plug (VDE)	R2J8-22-0125	A/S-POWER CORD:JDM, R2J8-22-0125 ,3 core plug		1	PCS
AC POWER CABLE	AC power cascade cable (3*2.5m 150CM)	3D2-22-10382	A/S-AC POWER CABLE:JDM, 3D2-22-10382 ,3*2.5m 150CM		1	PCS
AC POWER CABLE	AC power cascade cable (3*2.5m 50CM)	3D2-22-10363	A/S-AC POWER CABLE:JDM, 3D2-22-10363 ,3*2.5m 50CM		1	PCS
LAN CABLE	Signal cascade cable (120CM Cat-5)	3D3-23-10102	A/S-AC POWER CABLE:JDM, 3D3-23-10102 ,120CM Cat-5		1	PCS
LAN CABLE	Signal cascade cable (60CM Cat-5)	3D3-23-10101	A/S-AC POWER CABLE:JDM, 3D3-23-10101 ,60CM Cat-5		1	PCS
AC CABLE	AC power cable(With connect)	3D2-22-10358	A/S-AC CABLE:JDM, 3D2-22-10358 ,2.5m 35CM Seetronic-SAC3MPX		1	PCS

AC CABLE	AC power cable(With connect)	3D2-22-10359	A/S-AC CABLE:JDM, 3D2-22-10359 ,2.5m m ² 110CM Seetronic-SAC3FPX		1	PCS
AC CABLE	AC power cable(No connect)	3D2-22-10355	A/S-AC CABLE:JDM, 3D2-22-10355 ,1.0m m ² 175CM,2.5-40		1	PCS
AC CABLE	AC power cable(No connect)	3D2-22-10356	A/S-AC CABLE:JDM, 3D2-22-10356 ,1.0m m ² 30CM,2.5-40		1	PCS
AC CABLE	AC power cable(No connect)	3D2-22-10357	A/S-AC CABLE:JDM, 3D2-22-10357 ,1.0m m ² 30CM,2.5-40,2.5-40		1	PCS
SIGNAL CABLE	Signal cable	3D2-23-8025	A/S-SIGNAL CABLE:JDM, 3D2-23-8025 ,100CM Cat-5,two end network		1	PCS
SIGNAL CABLE	Signal cable	3D2-23-8001	A/S-SIGNAL CABLE:JDM, 3D2-23-8001 ,150CM Cat-5, two end network		1	PCS
SIGNAL CONNECTOR	Signal connector	R2J8-22-10032	A/S-SIGNAL CONNECTOR:JDM, R2J8-22-10032 , SE8FD05-01/IP65 ROHS		2	PCS
WATER-PROOF COVER	Water-proof cover	R2J8-22-10034	A/S-WATER-PROOF COVER:JDM, R2J8-22-10034 , CNAC-MPX ,match SAC3MPX, ROHS		1	PCS
WATER-PROOF COVER	Water-proof cover	R2J8-22-10035	A/S-WATER-PROOF COVER:JDM, R2J8-22-10035 , CNAC-FPX, match SAC3FPX, ROHS		1	PCS
DC OUTPUT CABLE	DC output cable (2.5m m ² 65CM)	3D2-22-10350	A/S-DC CABLE:JDM, 3D2-22-10350 ,2.5m m ² 65CM		1	PCS
DC OUTPUT CABLE	DC output cable (2.5m m ² 70CM)	3D2-22-10351	A/S-DC CABLE:JDM, 3D2-22-10351 ,2.5m m ² 70CM		1	PCS
DC OUTPUT CABLE	DC output cable (2.5m m ² 95CM)	3D2-22-10352	A/S-DC CABLE:JDM, 3D2-22-10352 ,2.5m m ² 95CM		2	PCS
DC OUTPUT CABLE	DC output cable (2.5m m ² 70CM)	3D2-22-10353	A/S-DC CABLE:JDM, 3D2-22-10353 ,2.5m m ² 70CM		1	PCS
DC OUTPUT CABLE	DC cable for receiving card(1.0m m ² 30CM)	3D2-22-10354	A/S-DC CABLE:JDM, 3D2-22-10354 ,1.0m m ² 30CM		1	PCS
FLAT CABLE	Flat cable (16P 30CM)	3D4-23-10040	A/S-FLAT CABLE:JDM, 3D4-23-10040 ,Flat cable (16P 30CM)		6	PCS
FLAT CABLE	Flat cable (16P 40CM)	3D4-23-10042	A/S-FLAT CABLE:JDM, 3D4-23-10042 ,Flat cable (16P 40CM)		1	PCS
FLAT CABLE	Flat cable (16P 60CM)	3D4-23-10024	A/S-FLAT CABLE:JDM, 3D4-23-10024 ,Flat cable (16P 60CM)		1	PCS
FLAT CABLE	Flat cable (16P 70CM)	3D4-23-10047	A/S-FLAT CABLE:JDM, 3D4-23-10047 ,Flat cable (16P 70CM)		1	PCS
CONNECT PLATE	Connect plate(130*100*4.0mm)	R2J8-42-0200	A/S-CONNECT PLATE:JDM, R2J8-42-0200 ,Connect plate(130*100*4.0mm)		4	PCS
CONNECT PLATE	Connect plate(130*50*4.0mm)	R2J8-42-2403	A/S-CONNECT PLATE:JDM, R2J8-42-2403 ,Connect plate(130*50*4.0mm)		1	PCS

SERVICE TOOL	Service tool (T type)	R2W8-29-2868	A/S-SERVICE TOOL:JDM, R2W8-29-2868 ,Service tool (T type)		1	PCS
SCREW	Screws (M3*8)	R2W8-22-1355	A/S-SCREW:JDM, R2W8-22-1355 ,Screws (M3*8),Fix SMPS, Air switch		28	PCS
SCREW	Screws (M3*6)	R2W8-22-0050	A/S-SCREW:JDM, R2W8-22-0050 ,Screws (M3*6),Fix receiving card, hub board		4	PCS
U DISK	U DISK	2S8-22-10025	A/S-U DISK:JDM, 2S8-22-10025 ,U DISK		1	PCS
M10 BOWLS	M10 Bowls	R2W8-22-0466	A/S-M10 BOWLS:JDM, R2W8-22-0466 ,M10 Bowls		16	PCS
KEY FOR DOOR	Key for back door	R2W8-29-3277	A/S-KEY FOR DOOR:JDM, R2W8-29-3277 ,Key for back door		1	PCS
SERVICE WIRE	Service wire for door	R2W8-29-10213	A/S-SERVICE WIRE:JDM, R2W8-29-10213 ,Service wire for door		1	PCS
SCREW	Screws for Mask (M1.2*6)	R2W8-22-1410	A/S-SCREW:JDM, R2W8-22-1410 ,Screws for Mask (M1.2*6)		101	PCS

6. Trouble shooting list

6.1 Display screen problem

The whole display screen cannot light up

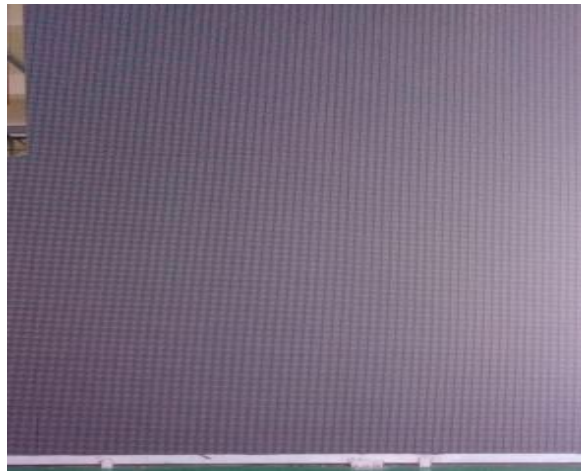

Check if the display screen is power on.

Check if the connection is broken between Sending box and the display screen, Check if the sending box is normal

Check if the first cabinet is working normally in the display screen

Check if the brightness setting is 0%

Check if the software setting is correct.

The whole display screen is blinking

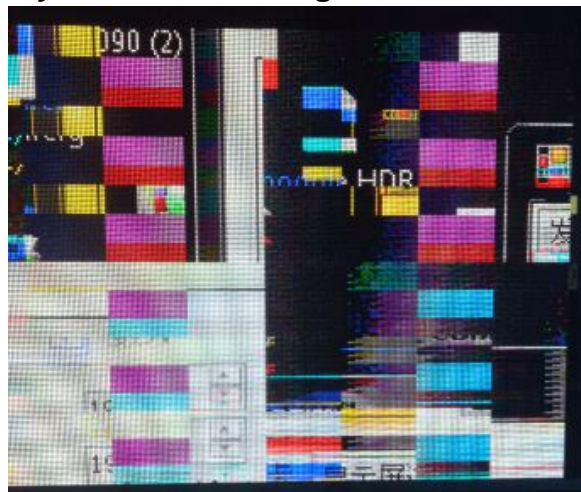

Check if the connection is broken between PC and Sending box

Check if the connection is broken between Sending box and the display screen

Check if the sending box is normal

Check if the first cabinet is working normally in the display screen

Check if the software setting is correct

Part of the display screen cannot light up

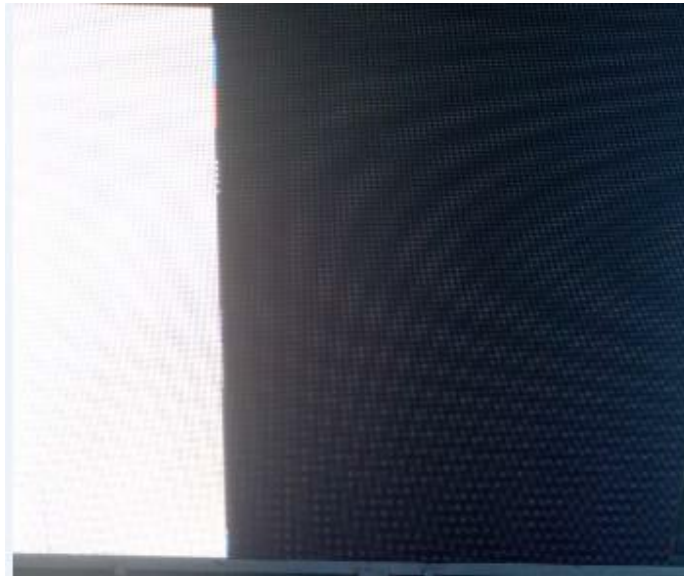

- Check if the part is power on.
- Check if the power supply is broken
- Check if the connection is broken between cabinet and cabinet
- Check if the receiving card is normal
- Check if the software setting is correct
- Check if the program in receiving card is correct

Part of the display screen is blinking



- Check if the connection is broken between cabinet and cabinet
- Check if the receiving card is normal
- Check if the software setting is correct
- Check if the program in receiving card is correct

The display screen is out of control



Check if the USB cable is connected well

Check if the USB cable is broken

Check if the software is running well

The display screen display wrong image



Check if the connection table setting is correct

Check if the software setting is correct

Check if the program in receiving card is correct

6.2 Cabinet problem

The cabinet cannot light up



- Check if the cabinet is power on
- Check if the connection is broken between cabinet to cabinet
- Check if the receiving card is normal
- Check if the power supply is broken in cabinet
- Check if the program for receiving card is correct

The cabinet is blinking



- Check if the receiving card is broken
- Check if the connection is broken between cabinet to cabinet
- Check if the program for receiving card is correct

Part of the cabinet cannot light up

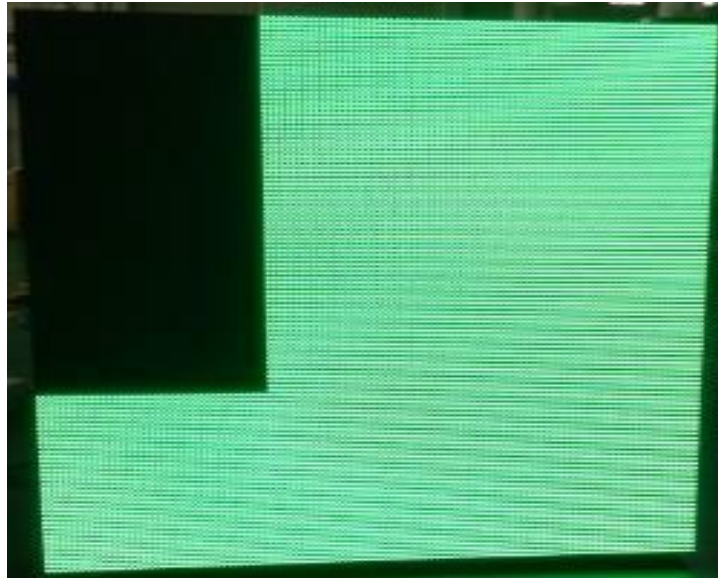

- Check if the power supply is broken
- Check if the flat cable is broken
- Check if the DC power cable is broken
- Check if the HUB board is broken
- Check if the module is broken

Part of the cabinet is blinking



- Check if the flat cable is broken
- Check if the HUB board is broken
- Check if the module is broken

6.3 Module problem

The module cannot light up

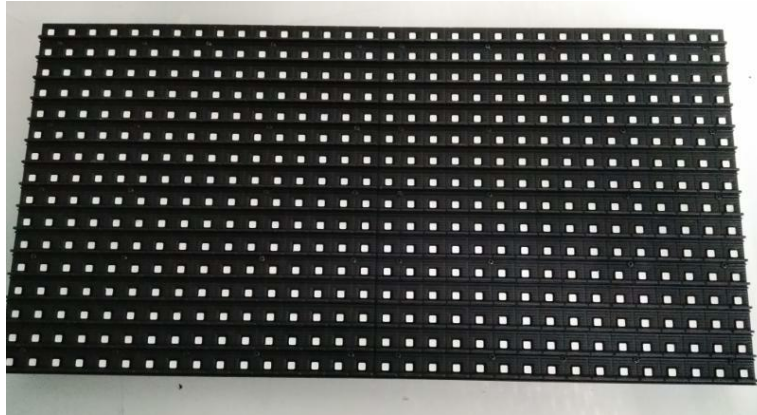

- Check if the DC cable is broken
- Check if the flat cable is broken
- Check if the module is broken
- Check if the last module is broken

The module is blinking

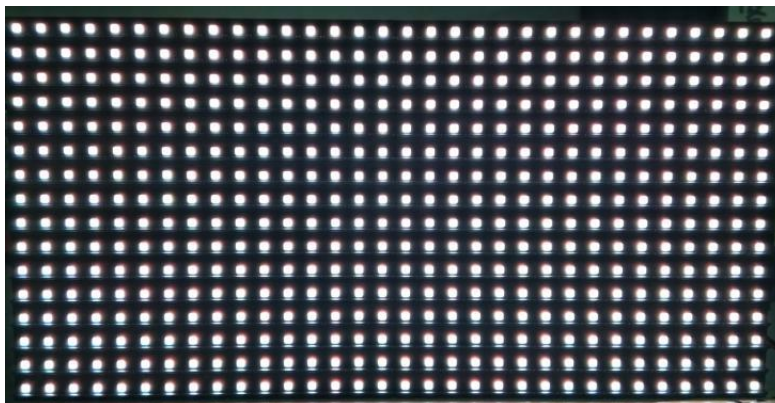

- Check if the flat cable is broken
- Check if the module is broken
- Check if the last module is broken

Block of module is broken or column of module is broken

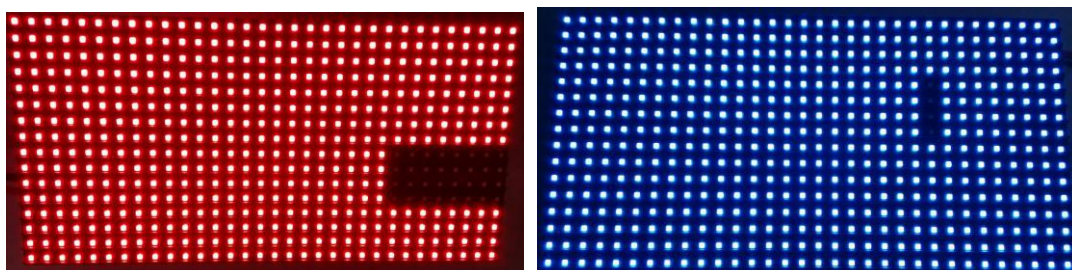

- Check if the driver IC is broken
- Check if the soldering of the driver IC is broken

Row of module is broken

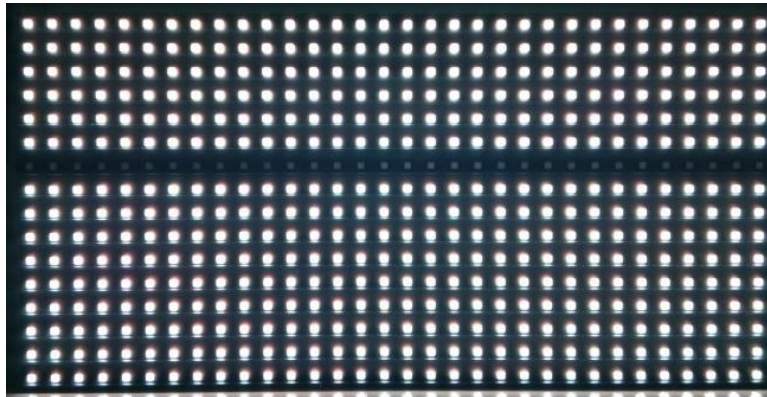

- Check if the 4973 IC is broken
- Check if the soldering of the 4973IC is broken

Pixel of module is broken



- Check if the led is broken
- Check if the soldering of led is broken

How to check the status of the transmitting card?

There are two lights on the transmitting card as shown as below.



If everything is right, the Red one will be off and the Green one will be blinking. Otherwise the user needs to check graphics card setting, DVI cable and transmitting card.

How to check the status of the receiving card?

There are three lights on the receiving card as shown below

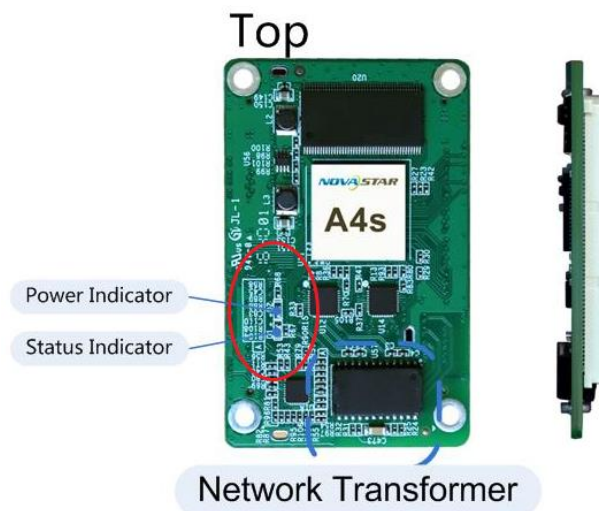

If everything is right, the Red one is blinking, and the Green one is on (no blinking). Otherwise the user needs to check receiving card, the programmer, and the Cat-5 cable connect into this scan board.

How to check the input and output problem of board?

Usually there are one input and one output on board. If a board is broken, we can get data from another board to check the input of this board is good or not. Also, we can get data from last board to another board to check the output of last board is good or not.

Checking Method

Jump signal from the last module to another module

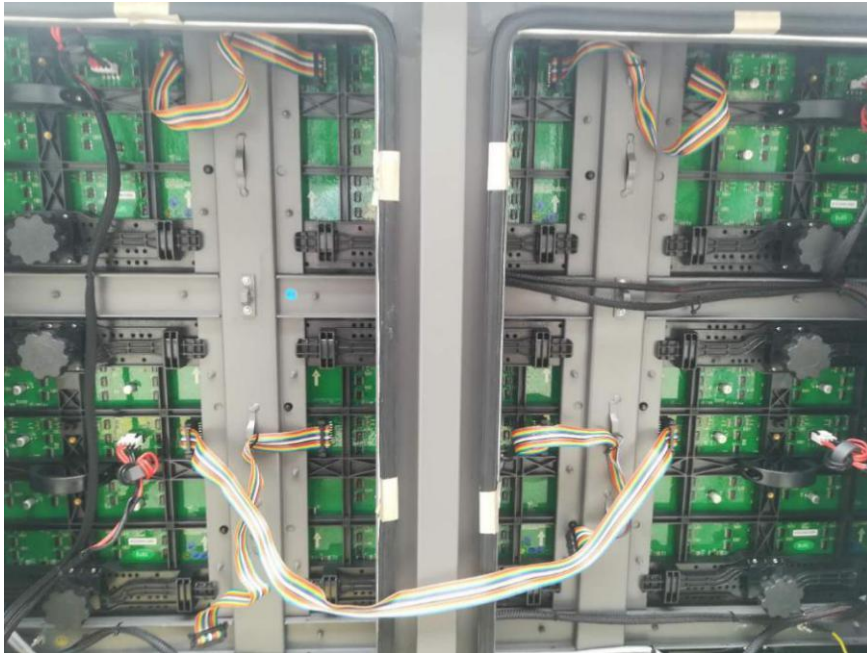

Jump signal from the current row to the next row



7. Installation Guides

7.1 Mechanical requirements and installation

Support structure

The support structure has to be provided and installed by the customer because they vary from project to project. The following issues must be considered:

Weight tolerances: Ensure that the support structure and the floor on which or the wall against which the support structure has to be installed, is qualified to handle the complete weight of the LED display screen.(which can be provided by manufacturer.

Environmental conditions: Humidity, wind, temperatures, rain, snow etc.

Location: Outdoor/.Indoor, altitude, etc. Usually, for outdoor display screen, the customer should build top cover and side cover for IP protection (Including waterproof and dust-proof)

Ground stability

Front clearances: For making sure there is sufficient free area in front of the LED display screen and respect the maximum viewing angles and distance.

Local regulations regarding such installation

Tools for installation

Please prepare below tools before installation

Slot type screwdriver, Philips type screwdriver, spanner, Hexagonal bar, Hexagonal head screwdriver, scissors, pincers, wire cutters, hammer, electric drill, electric welding, Multi-meter, etc.

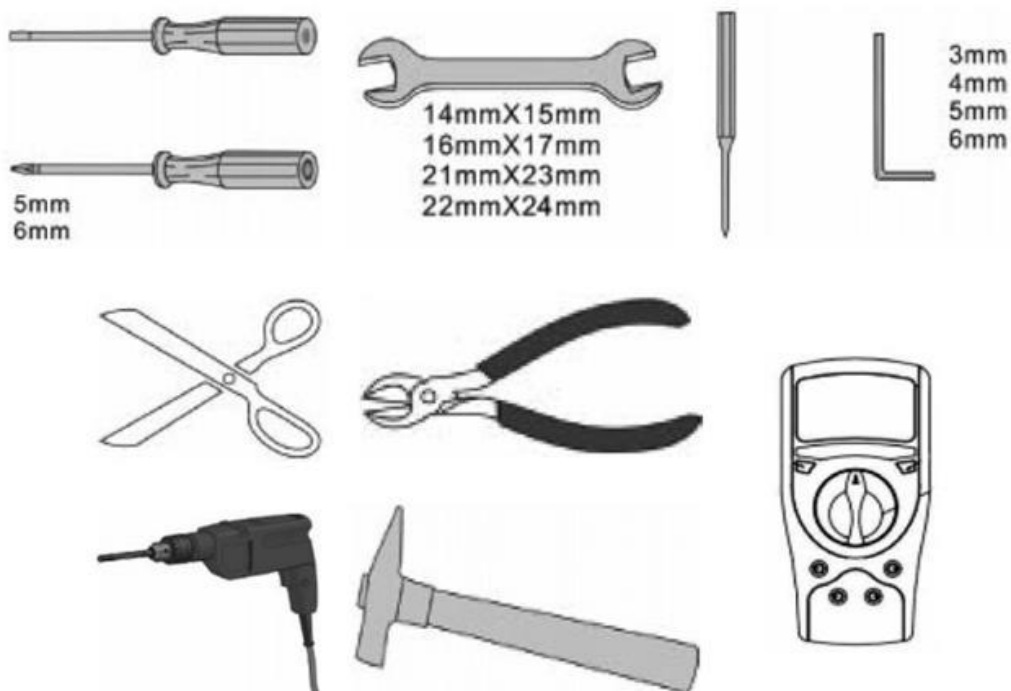

Installation of cabinets



Fixing of connect plate

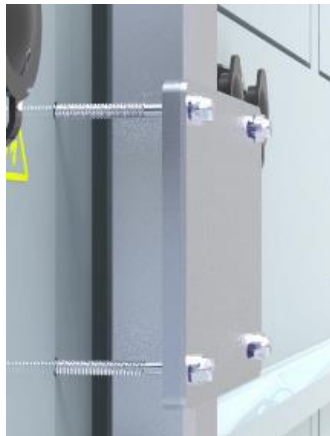

Details of installation

1. First measure the under surface of the structure as a horizontal plane and the side of the structure as a vertical plane by spirit level as shown as below

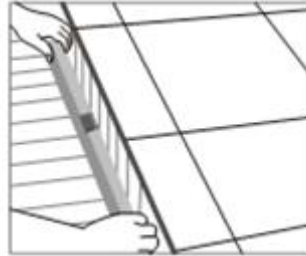

2. First cabinet is placed in the middle of the bottom row with the stud rods in the middle of the corresponding slot as shown as below, do not fix the nuts tightly.

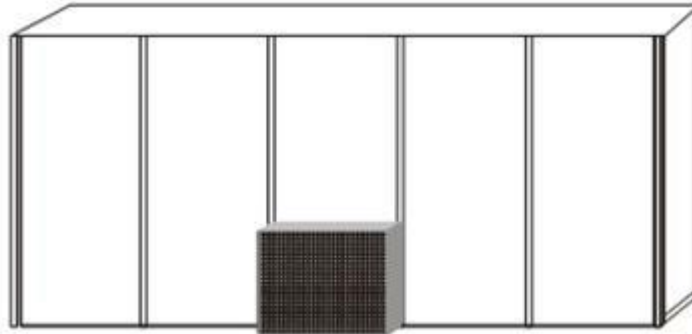

3. Place the cabinets beside one another from the middle of the row to the sides as shown as below, do not fix the nuts tightly

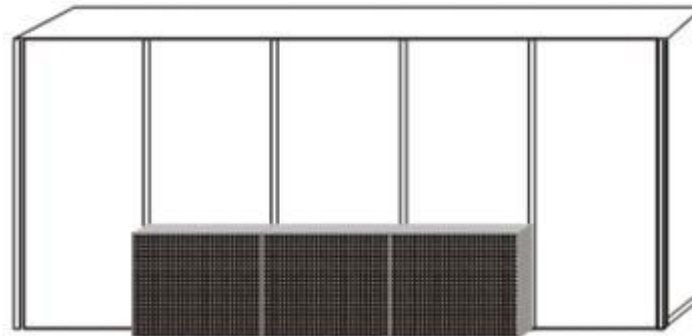

4. Finish the first row by same way as shown as below.

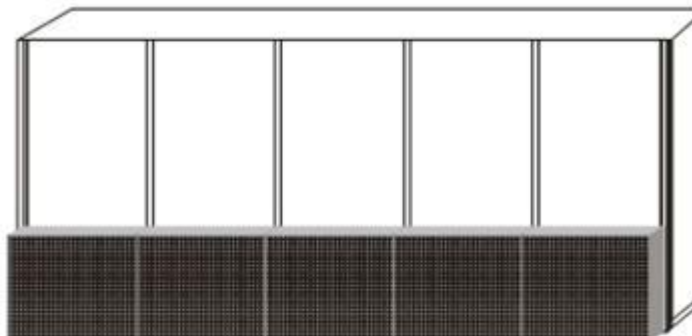

-
5. Measure the first row by spirit level, make sure it is installed horizontally, then fix the nuts tightly between the cabinets and the connect plates.
6. Place the middle cabinet in the second row, adjust it and fix it but not tight. Make sure it is installed horizontally and vertically, then fix it tightly as shown as below

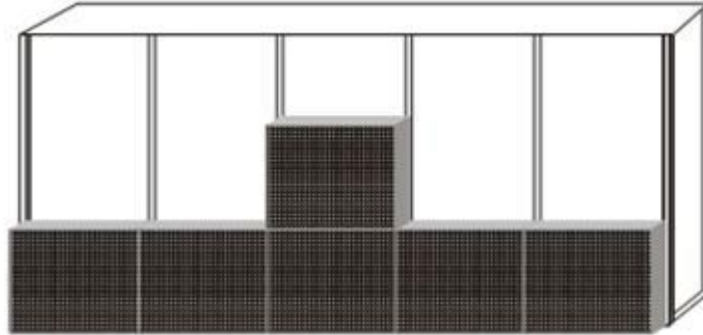

7. Finish the second row by the same way as shown as below

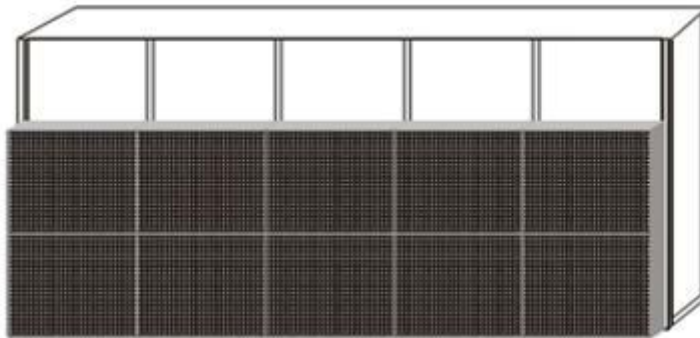

8. Finish the rest installation of all the cabinets by the same way as shown as below.

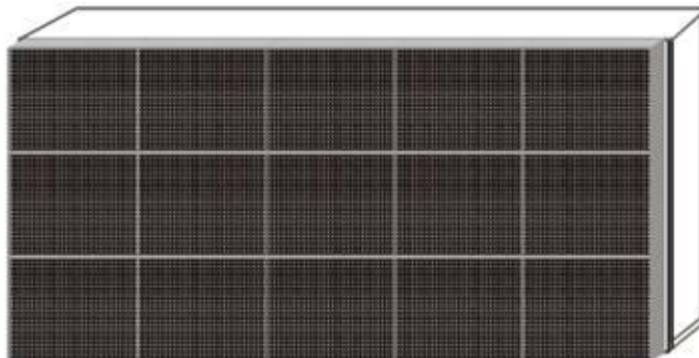

7.2 Electrical requirements

Power system

Power voltage must be in the range of the specification value.

It is recommended to use a power distribution system (a power distribution system with a separate neutral and grounding conductor in order to avoid large ground current loops due to voltage differences in the neutral conductor).

The total electrical installation should be protected by an appropriately rated disconnect switch, circuit breakers.

The electrical installation must only be performed by a qualified electrician. Electrical connections must comply with all applicable national and local codes.

Cabling & Connection

All internal cabling must be properly connected and seated.

All power wiring must be from circuit breaker protected lines. Do not connect to an unprotect circuit.

Do not route power and communication wires in the same conduit. Separate conduits must be run for communication wires and power wires. However, fiber optic wire may be run in the same conduit with power wires.

Grounding

The LED display screen must be properly grounded according the applicable national and local codes.

Properly grounding every display cabinet is necessary as it is essential to prevent shock, shock hazards, and fire hazards.

Lighting Strike Protection

A LED display screen cabinet bonder to an earth ground aims to dissipate the high voltage and current from a lighting strike. The resistance of the grounding electrode must be as low as possible. However, damage can still occur to a LED display screen cabinet`s electronic equipment from lighting voltage transients.

Though some surge protection is incorporated into a LED display screen in order to protect the display from high voltage lighting transients, surge protectors need to be installed.

Lighting Strike Protection of Electric Closet

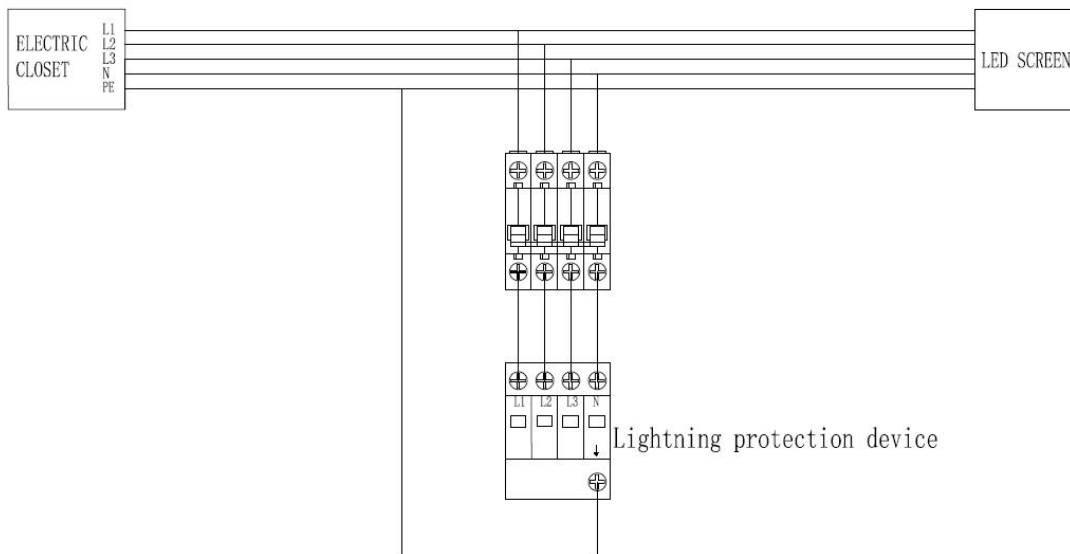

Every electric closet of LED display screen must be installed with lightning protection device equipment. The requirement specification should be same as shown below.

Nominal discharge current I_n (8/20 μ s) :20 kA

The maximum discharge current I_{max} (8/20 μ s):40 kA

Voltage protection level:

Up in I_n AC385-505V: ≤ 1.7 kV

TA <25ns

Power distribution box

Since the LED screen product is an industrial-class product and has a relatively large power, it uses a high-power switch power supply. So, the start-up impact current at startup is relatively large. And then, the air switch which is used in the power distribution box needs to use a D-type switch. Prevent the screen from jumping when starting

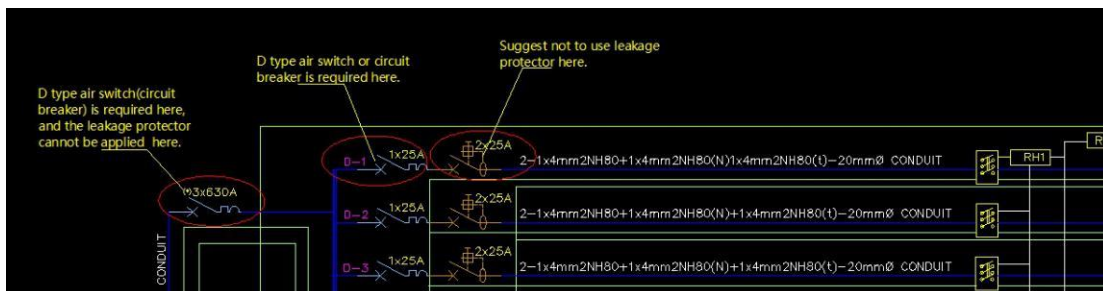

Cooling System

If the customer want that the LED screen working normally for a long time. He should pay attention for the cooling system for control the temperature inside the steel structure, at least less than 45 degrees Celsius.

A. If the LED display dimension is less than 20 square meter, not need to install air condition, 2 air flow is enough.

B. If the LED display dimension is more than 20 square meter, and the LED display screen is installed on the wall with 1 meter distance, must to install enough air condition or air flow as the cooling system.

If use air flow , it should be installed on two sides of the LED screen. At least per 3-4M height should install 2 air flow on two sides of LED screen, the air flow should use suction type one. it means the air flow should take out the air from structure and cabinet. And if the LED display screen is more wide than 10M, should install more air flow inside steel structure to make sure all the area air can be took out . Usually per 5M need to add a air flow. When the air flow is installed , the protection net should be also installed for protect service person and equipment. Also there should be air inlet on the bottom of the steel structure.

If choose air condition, should install it inside the steel structure and make sure there is enough space for installation of air condition. Generally, air condition type is 1.5P, 2P or 3P. Per 9-12 square meter will use 1P air condition, depend on local temperature.

C. If the LED display use a pole steel structure to hold it, the best cooling system is air flow. Install the air flow on the upper area of the LED display screen, and put the air inlet on the bottom of the steel structure, there will be a complete air convection inside the steel structure, will get the best ventilation effect.

8. Connection of the LED screen

8.1 Connection for equipments

Connection between Sending box and PC

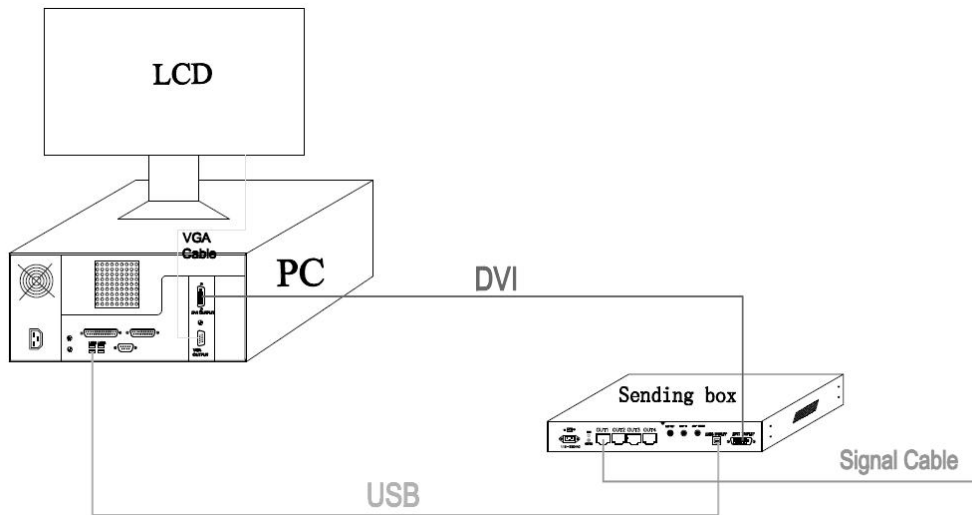

8.2 Port of Cabinet

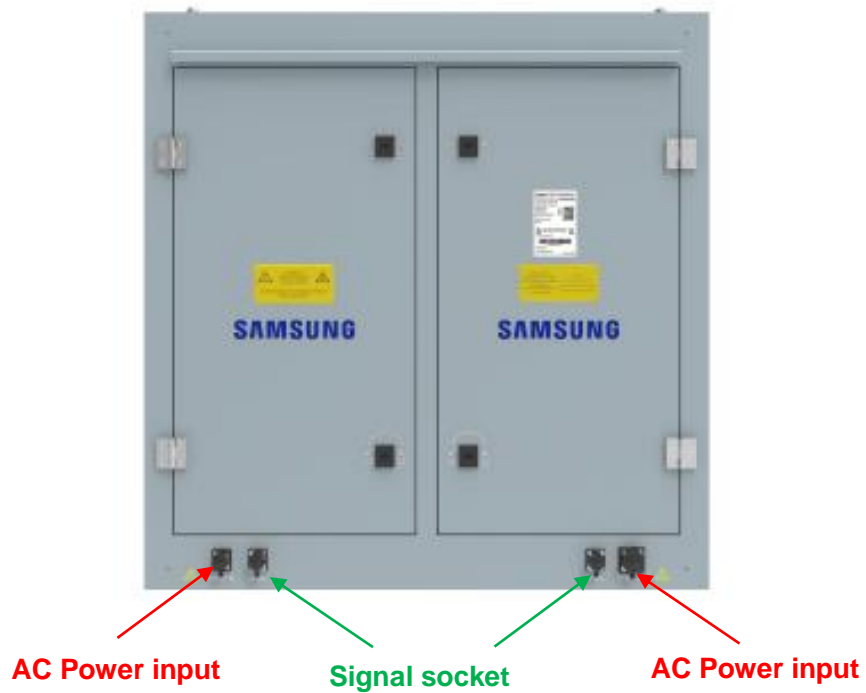

8.3 Connection for power cables



Usually the length of the AC input cable depend on the distance between the power distribution and LED display screen, it is not certain.

The AC cascade cable: 3*2.5 m² 50cm, two end with connector.

Attention: For 220-240V AC power voltage countries and areas, each AC input cable can offer power for 5 cabinets. But each AC input cable only can offer power for 2 cabinets in 100-120V AC power voltage countries and areas.(XAT 6.7&10)

Attention: For 220-240V AC power voltage countries and areas, each AC input cable can offer power for 6 cabinets. But each AC input cable only can offer power for 3 cabinets in 100-120V AC power voltage countries and areas.(XAT 16)

8.4 Connection for data cables



Usually the length of the AC input cable is 50M, but sometimes it depend on the distance between the control room and LED display screen, it is not certain.

The signal cascade cable: Cat-5 or Cat-6 60cm, two end with connector.

The signal cascade cable: Cat-5 or Cat-6 120cm, two end with connector.

Attention: Each signal input cable can offer signal for 30(XAT6.7,)60(XAT10),160(XAT16) cabinets.

8.5 Cabinet arrangement drawings sample

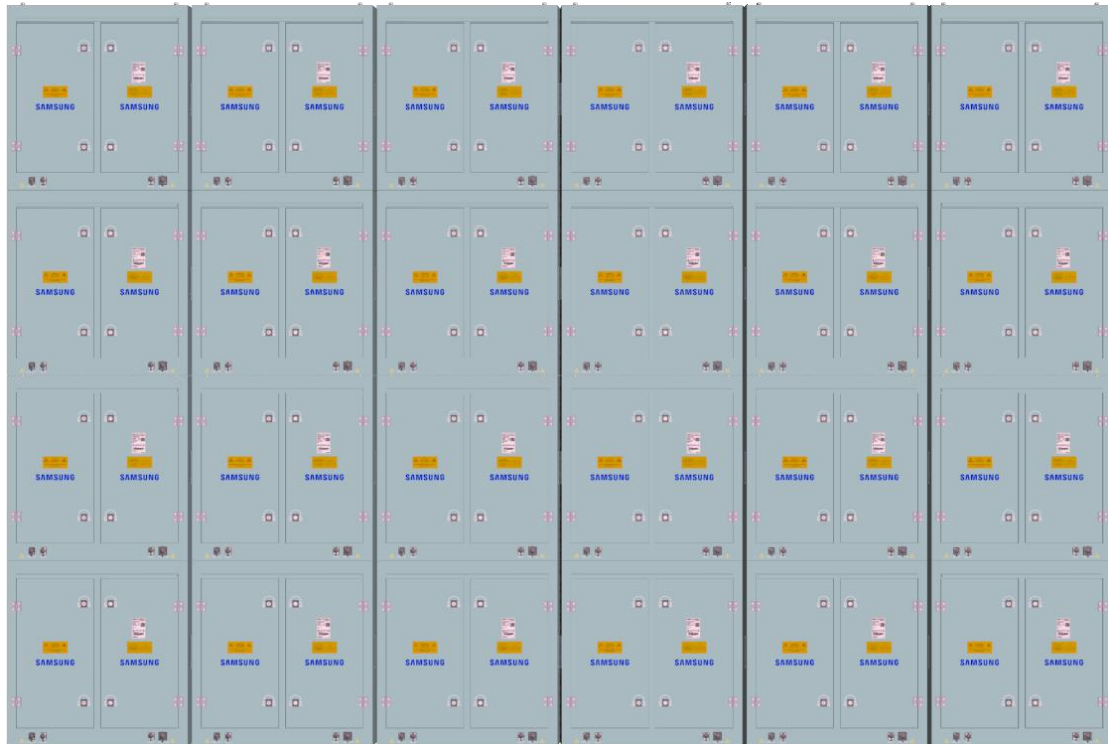

Every project there will be a cabinet arrangement drawing to show how to install the cabinet in turn. This is only a sample to show you what it like.

Note: For waterproof, please use the water-proof cover to cover the last cabinet which have no connector to the next cabinet.

9. Control system setting

9.1 Software setup

It is sample to install the <NovaLCT> as below:

Double-click NovaLCT setup file,(see Fig.9-1), select <Next> to start, follow the guides to finish the setup, software version:NovaLCT V5.2.0 .



Fig 9-1

When the setup of the < NovaLCT> is completed, the <LED software> will show up in the <Start/<Program>. Click to start operation after entering < NovaLCT in the program as Fig. 9-2 shown

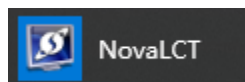

Fig 9-2

There are shortcuts of < NovaLCT-Mars> in the desktop as icon shown, double-click it to start up the program.



9.2 NovaLCT Main interface

This section describes how to use NovaLCT to set screen parameters as follows:

Enter NovaLCT main interface

Step 1: Start "NovaLCT", click "User" → "Advanced Login", enter `User login` window as shown in Fig.9-3

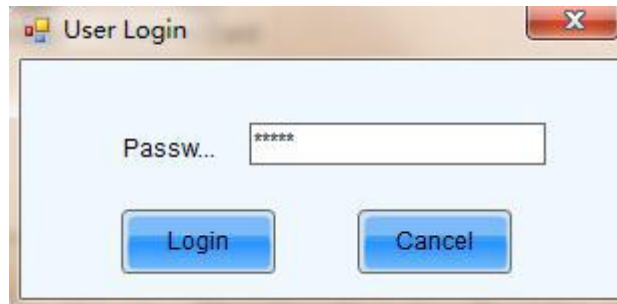









Fig 9-3



Step 2: Input the password `admin`, enter the NovaLCT main interface for advanced users as shown in Fig 9-4



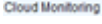

Fig 9-4

9.3 Main Menu

Menu		Description
System	Reconnect	This is used to reconnecting the NovaLCT to the synchronous system.
Settings	Screen Configuration (Advanced user)	 Shortcut button:  This is used for configuration of the LED screens.
	Brightness	 Shortcut button:  This is used for adjusting the LED display brightness. There are two ways for brightness adjustment, automatic brightness and manual brightness.
	Multi-function Card	 Shortcut button:  This is used to open the page for Multi-function card configuration.
	Multiple-screen Management	This is used to open the page for combination display configuration. It makes the management of brightness control and monitoring of multiple LED displays easier when these LED displays are combined together.
	Hardware Information	This is used to check the information about the current LED display control system.
	Prestore Screen	Enter the restore screen, booting screen and no signal (including the disconnected network cable and no DVI signal) screen settings can be conducted.
	Advanced Color Configuration (Advanced user)	<ul style="list-style-type: none"> Factory setting (current gain, RGB brightness). Configuration color space (original color space, target color space). Color temperature table.
	Adjust Screen Effect (Advanced user)	Enable/Disable 18-bit mode and ClearView mode.
	Cloud Monitoring	 Shortcut button:  Register the display screen to NovaiCare.

Menu		Description
	Module Flash	View correction coefficients of the receiving card and module. Save correction coefficients in the receiving card and module. Test whether Flash is normal.
	Receiving Card Relay (Advanced user)	Set parameters for the receiving card relay. Reset the time of the receiving card.
	Configure Information Management	Import/Export all the configuration files.
	The Main Window Starting Position	Set the initial coordinates.
Tools	Calibration	 Shortcut button: Calibration Calibrate the screen and manage the calibration coefficients.
	Screen Control	 Shortcut button: Screen Control Perform the screen control functions which include "Black Out", "Freeze" and "Normal". Besides, self test options are also provided.
	Monitoring	 Shortcut button: Monitoring Enter the monitoring page to view the monitoring results or set the monitoring parameters.
	Led Error Detection	Enter "Led Error Detection" page to perform LED error detection after the screen has been properly configured.
	Multi-batch Adjustment	Adjust the brightness of the display according to the batches of cabinet.
	Controller Cabinet Configuration File Import	Add/Delete configuration files. Modify file name. Save the configuration file in hardware.
	Quickly Adjust Dark or Bright Lines	Adjust or restore dark or bright lines caused by cabinet splicing.
	Video Control	Input setting, output setting and stitching

Menu		Description
		management of video processor.
	Module ID Setting (Advanced user)	Perform module ID configuration to make module management easier. Some modules do not support ID configuration, please contact NovaStar's technicians for details.
	More	Includes Reset Run Time , Brighter Pixel Correction and Bite Error Detection . Reset Run Time : Reset the run time displayed on the LCD of each cabinet. Brighter Pixel Correction : Solve the problem that the brightness of a calibrated screen is not uniform. Bite Error Detection : Detect the data packet loss during communication between receiving cards.
Plugins	Test Tool	 Shortcut button:  To open the page which all test tools (test content) for LED displays testing are in.
	Calculator	Click on this item will open the Microsoft Windows calculator.
	External Program	Click on this item will add an external program.
	DHCP Service	Obtain the IP address assigned by the server.
User	Advanced User Login	Log in the synchronous system with the password "admin".
	Enter Demonstration mode	Experience the related functions of the synchronous system. No hardware connection is required and the password is "admin".
	Connect Asynchronous Terminal	Log in the multimedia player.
Language	-	Support multiple user interface languages.
Help	User Documents	View software-related user documents.
	Update log	View software update logs.
	About	View software version, company name and other information.

9.4 Screen Config

To configure a LED display with system configuration files, click **Screen Config** button from the tool bar or select **Tools->Screen Config** from the main menu of the NovaLCT application main interface to open the Screen Config window. Shown in Fig.9-5 is the Screen Config window.

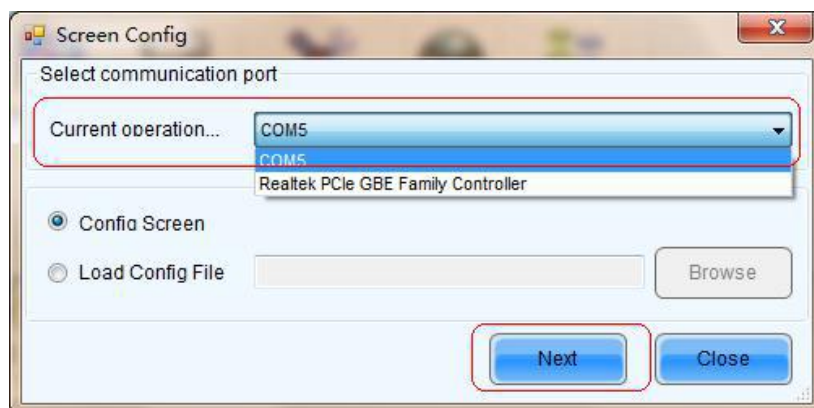

Fig 9-5

Step 1: Set the **Current Operation Communication Port**

This is the port that connects the sending board (controller) to be configured to the control computer. If only one serial port of the computer is used to connect the LED display control system, the used serial port will be automatically set as the current serial port. Otherwise, if multiple serial ports are used to connect control systems to the computer (one serial port for one control system), the serial port that is used to connect the control system which is to be configured should be set as the current serial port. If it's the mode with no sending board, please set the corresponding network port.

Step 2: Load system configuration file

Select **Load Config File** option, use **Browse** button to select the system configuration file to be loaded and then click **Next**. The selected configuration file will be automatically loaded to the LED display system. The LED display system will have been configured when the load operation is finished.

Sending box setting

Enter `Screen Config`, choose `Sending Board` as shown in Fig 9-6.

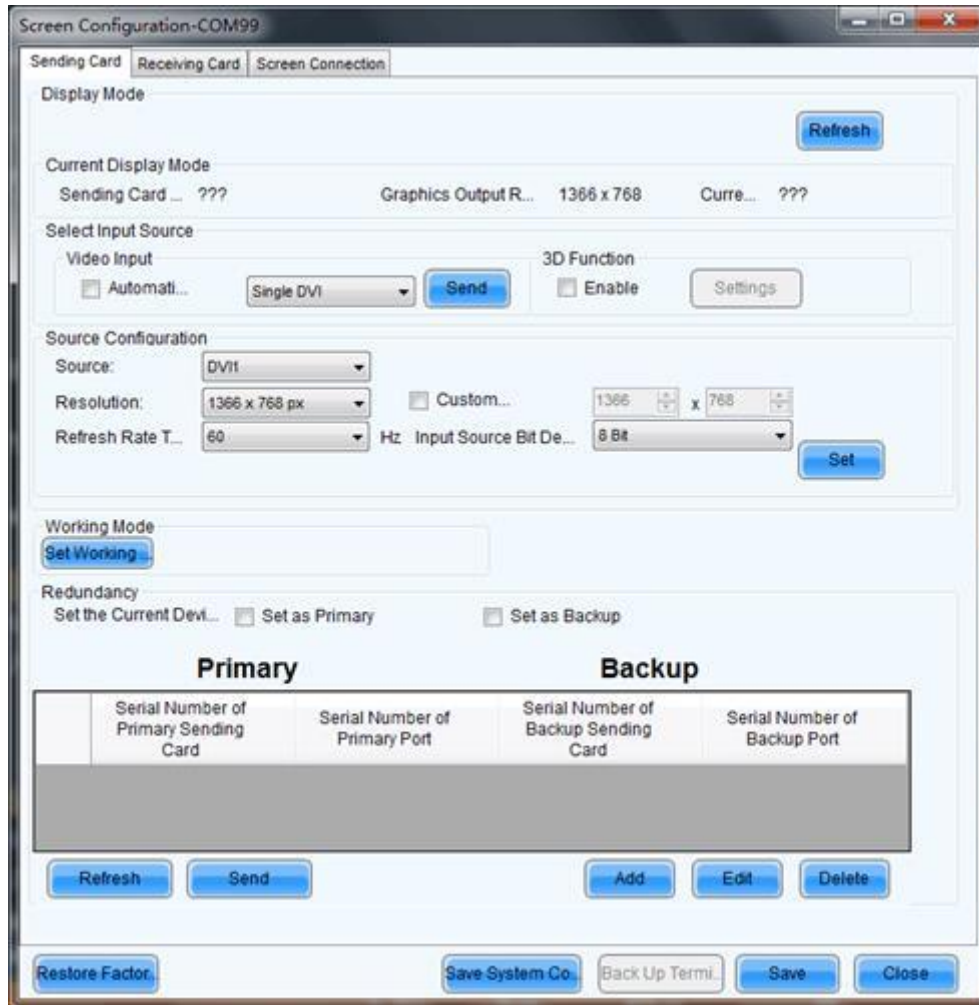

Fig 9-6

In this interface, the user can set up `Sending Board`, `Scan Board` and `Screen Connection`

Attention: Usually the resolution of transmitting card is bigger than the resolution of the LED display screen. For example, the resolution of the LED display screen is 1400*720, the user can not choose 1280*1024, must choose bigger than 1400*900.

Another notice: Every RJ-45 output of transmitting card can offer 650,000 pixels, if your LED display's pixels are more than this, you must use 2 cat-5 cable or more.

Scan Board setting

Choose the `Scan Board` as shown in Fig 9-7.

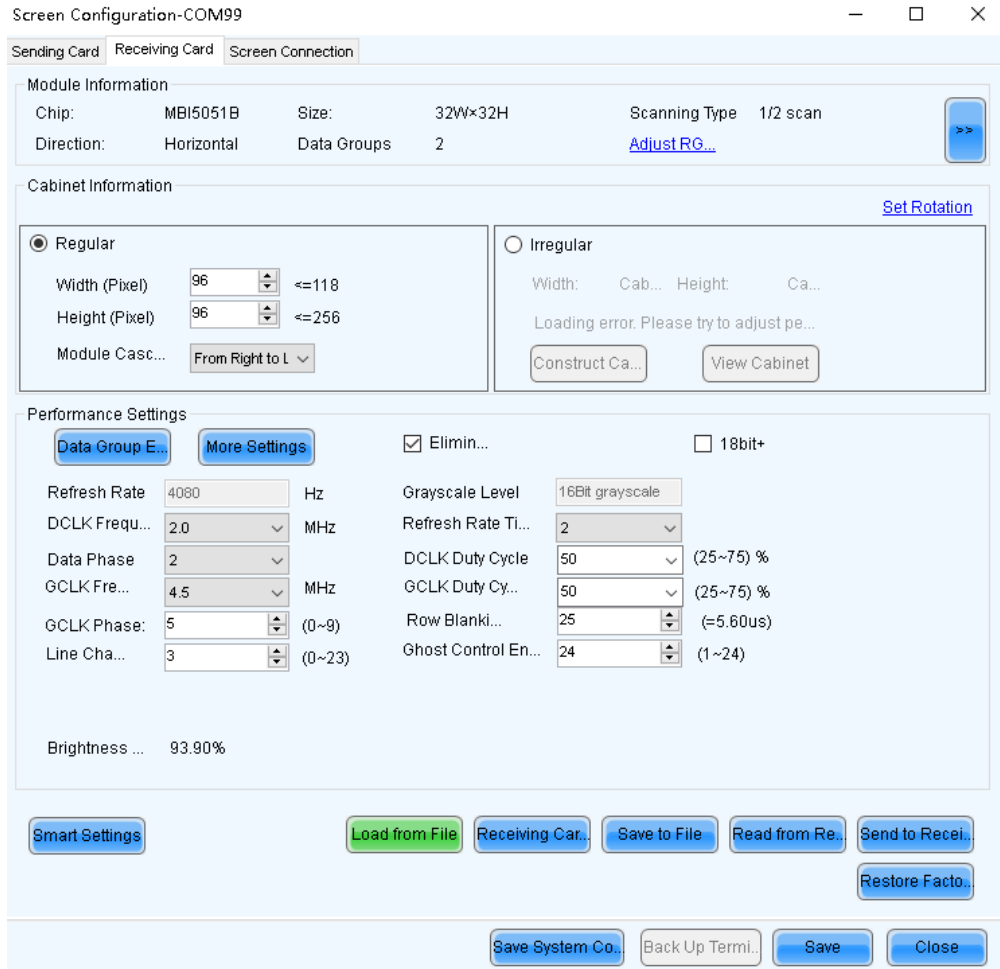

Fig 9-7

I Quantity

This is the number of LED displays that are to be configured.

I Configure

This button is used to load the Screen Number to the NovaLCT application.

I Read form HW

This is used for the application to read the LED display information from the hardware.

I Detect Communication Status

This is used to check whether the communication within the current LED display is good.

I Read the Number of Receiving Cards

Get the number of receiving cards loaded by each of the Ethernet ports of the current sending card.

I Enable Mapping (only supported by some receiving cards of the Armor series)

When this function is opened, current serial number of the cabinet and its Ethernet port No. will be shown on the cabinet.

I Load from File

Load screen information files save on control computer.

I Save to File

This is used to save screen information files as screen information file (*.scr).

I Send to HW

This is used to send the LED display configuration settings to the connected sending card.

I Restore Factory Settings

Reset current parameter configuration to factory settings.

I Restore System Configuration

Reset current operating status of the system (or sending card, or receiving card) to the status in the backup file.

I Back Up System Configuration

Back up current configuration parameters.

I Save System Configuration File

Save system configuration parameters as a file.

I Save

This is used to save the settings to a FLASH chip. The saved data won't be lost even the hardware is powered off.

Screen types include standard screen and complex screen. Configurations for different types of screen will be given as follow.

Attention:We have saved all the program into the receiving card before delivery, not need to save it again. We have saved all the programmer file and control system software into

the U disk  , please check if you got it in the package of spare parts. Also you can ask it form out factory.

Please do not make a new programmer file for RV card by yourself, usually it will caused mistake when you use it.

Screen connection setting

Choose the `Screen Connection` as shown in Fig 9-8.

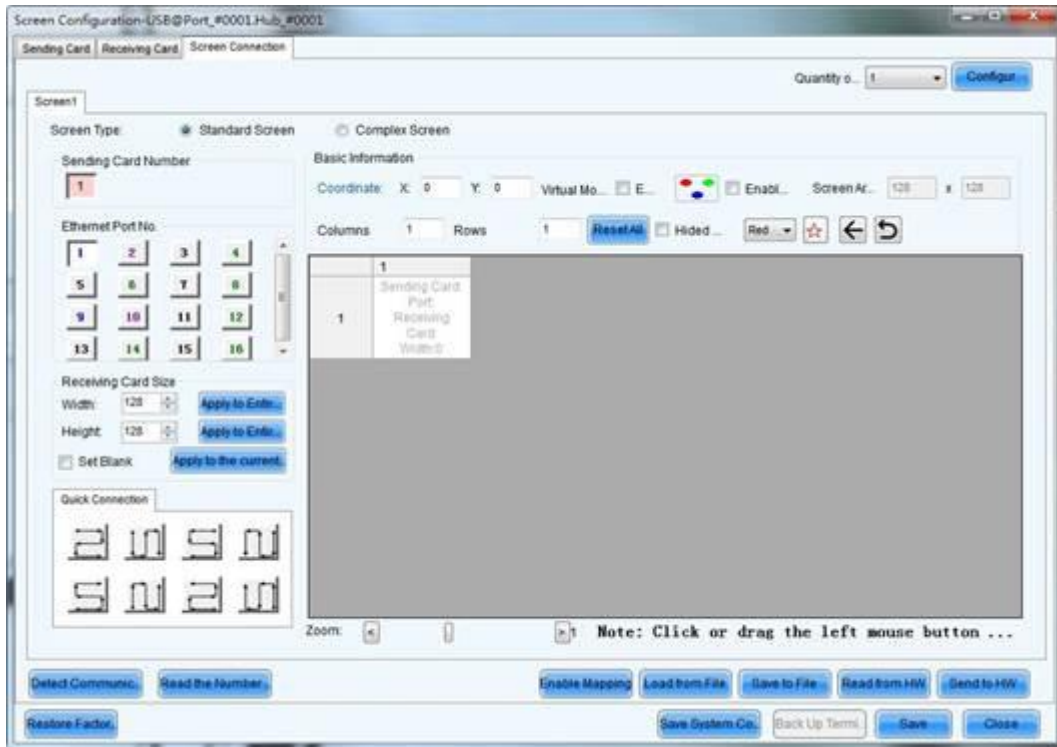

Fig 9-8

I Quantity

This is the number of LED displays that are to be configured.

I Configure

This button is used to load the Screen Number to the NovaLCT application.

I Read form HW

This is used for the application to read the LED display information from the hardware.

I Detect Communication Status

This is used to check whether the communication within the current LED display is good.

I Read the Number of Receiving Cards

Get the number of receiving cards loaded by each of the Ethernet ports of the current sending card.

I Enable Mapping (only supported by some receiving cards of the Armor series)

When this function is opened, current serial number of the cabinet and its Ethernet port No. will be shown on the cabinet.

I Load from File

Load screen information files save on control computer.

I Save to File

This is used to save screen information files as screen information file (*.scr).

I Send to HW

This is used to send the LED display configuration settings to the connected sending card.

I Restore Factory Settings

Reset current parameter configuration to factory settings.

I Restore System Configuration

Reset current operating status of the system (or sending card, or receiving card) to the status in the backup file.

I Back Up System Configuration

Back up current configuration parameters.

I Save System Configuration File

Save system configuration parameters as a file.

I Save

This is used to save the settings to a FLASH chip. The saved data won't be lost even the hardware is powered off.

Screen types include standard screen and complex screen. Configurations for different types of screen will be given as follow

Attention: Usually we will make the connection table file and send it to the user, but if you want use it, you must connect data cables according to data cable connection drawing which the manufacturer provides. Otherwise you should make a new one for your own connection. More operation details for Nova Control system should be check in software.

9.5 Advanced color configuration

Advanced color configuration includes factory setting, configure color space, color temperature table and color adjustment. The target color space plan and color temperature table configured here can be called directed when adjusting brightness.

Choose **Settings > Advanced Color Configuration**, as shown in Figure 9-9.

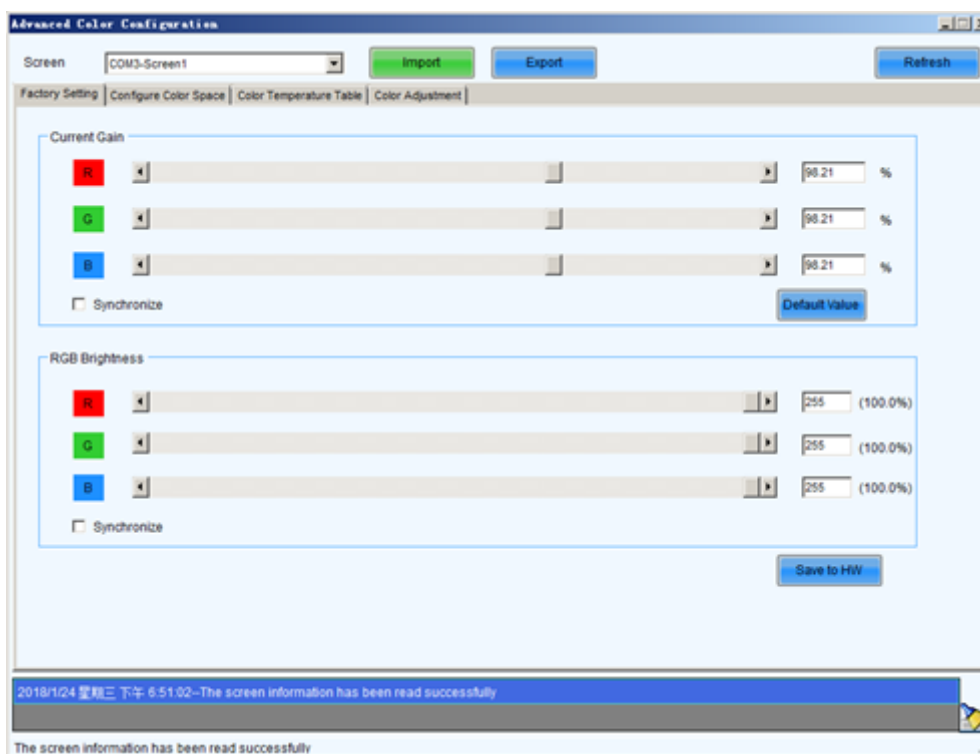

Figure 9-9 Advanced color configuration

Factory Setting

| **Current Gain:** Some chips support current gain control.



| **Default Value:** click to restore the default values.

| **RGB Brightness:** adjusts brightness of R/G/B colors respectively, or check **synchronization** to adjust the three colors synchronously.

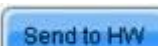

| **Send to HW:** Save the current gain and brightness to hardware.

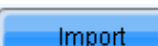

| **Import:** Import local color configuration file.

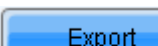

| **Export:** Export current color configuration and save on local disk.

Color space configuration

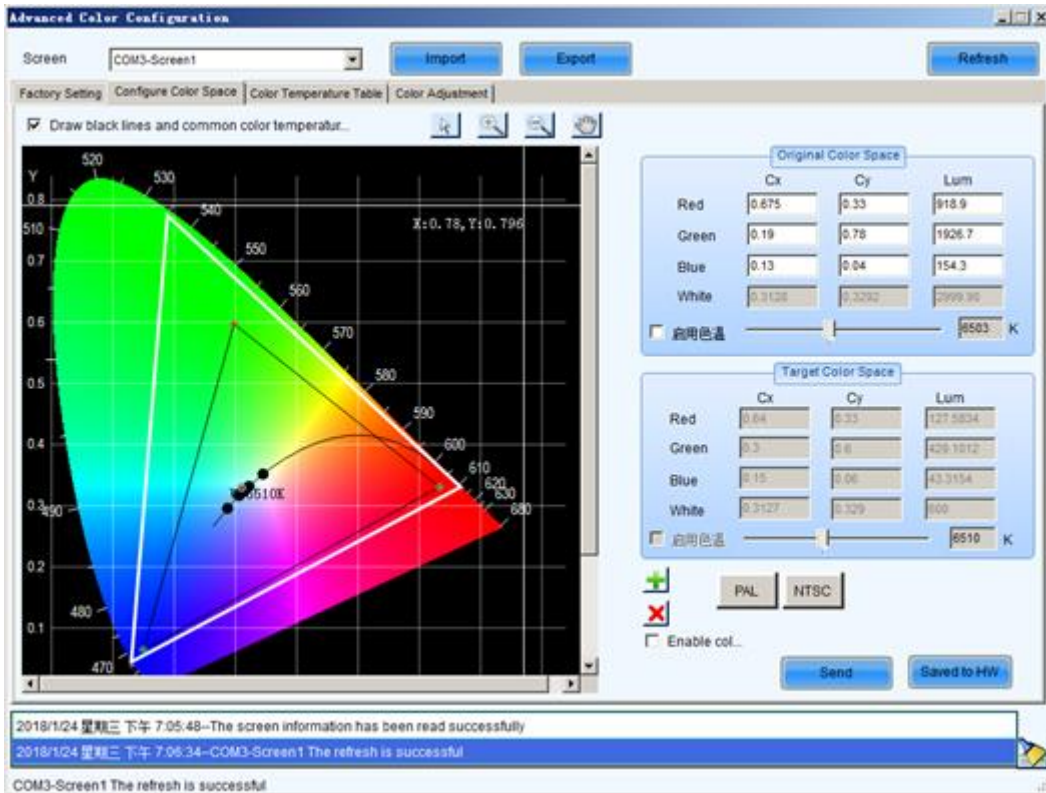

| Draw black lines and common color temperature points: When this option is selected, a black line (color temperature curve) and common color temperature points (solid dots) are shown.

| Original color space: It is suggested to use a light gun to measure current CIE coordinates and brightness and fill out properly, use original color space as basis for adjusting color temperature.

| Target color space: The black triangle in the color space on left side of the interface is target color space, drag your mouse to change four-color target pixel.

It is also allowed to directly change all coefficients of the target color space, when adjusting the target color space, preview the adjustment results on the LED screen until satisfaction.

| PAL/NTSC: Standard system, click the button with your mouse, the target space will be set to either PAL or NTSC system.

| Enable color space adjustment: After being checked, the target color space values can be applied to the entire LED display.



| : Add color space information, save current color space as a customized color space information to be called at any time in the future.



| : Delete selected customized color space information. Select customized color space information to be deleted, click this button, the color space information will be deleted.

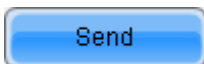



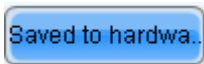

| : Send current calibrated color space and target space to LED display.



| : Save current calibrated color space and target space to hardware.

Color temperature table

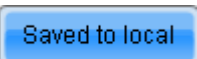
-
- |  : Add color temperature segments.
 - |  : Compile selected color temperature segment.
 - |  : Delete selected color temperature segment.
 - |  : Clear all color temperature segment.
 - |  : Save the color temperature table to local space.

Color Adjustment

Adjust hue, contrast and saturation of the LED display.

This function is only supported NovaStar Pro HD for the moment.

9.6 Adjust the brightness and Gamma

Click **Brightness** button from the tool bar or select **Setting->Brightness** from the main menu of the NovaLCT application main interface to open the **Display Adjustment** window for brightness, Gamma and color temperature adjustment.

There are two methods to adjust the brightness: manual adjustment and automatic

adjustment, after adjustment is done, click  and save the adjustment results to hardware.

Manual Adjustment

On the **Brightness Adjustment** page, select **Manually Adjustment**.

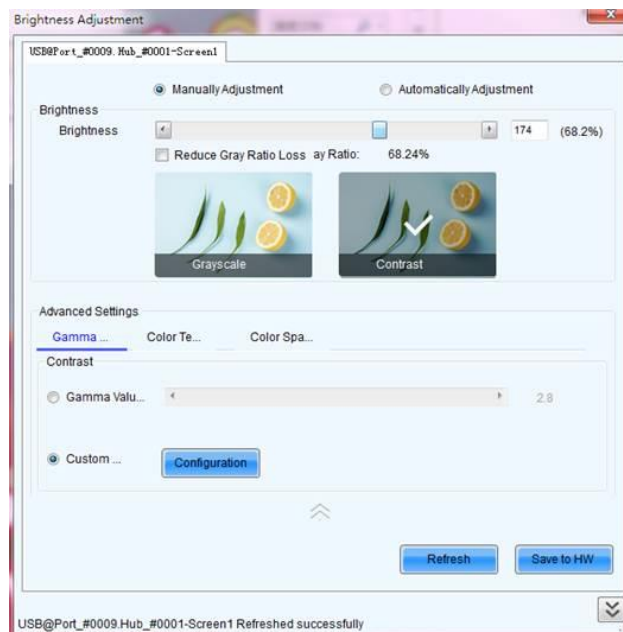

Figure 9-10 Manual adjustment

Brightness

Set the brightness value following the operations below.

- I Drag the slider or enter a number to set the brightness.
- I Select **Reduce Gray Ratio Loss**. Different brightness correspond to different gray ratios.
- I Select the **Grayscale** or **Contrast** mode.

Advanced Settings

Advanced settings include adjustment of Gamma, color temperature and color space.

- I Gamma adjustment
 - Gamma Value Adjustment: Select **Gamma Value Adjustment** and drag the slider to adjust the value.
 - Custom Gamma Adjustment: Select **Custom Gamma Adjustment** and click **Configuration** to enter the **Gamma Adjustment** page.

- Select independent Gamma adjustment mode, including **Red Gamma**, **Green Gamma** and **Blue Gamma**. (Only the MCTRL4K and MCTRL660 PRO support individual Gamma adjustment for RGB.)
- Set the grayscale bit value.
- Drag the slider to adjust the Gamma value.
- Under **Recommended Gamma**, select the Gamma mode, including **Original**, **Mode A** and **Mode B**.
- Under **Picture Quality**, select the picture quality mode, including **Soft Mode** and **Enhanced Mode**.
- Click **Send**.

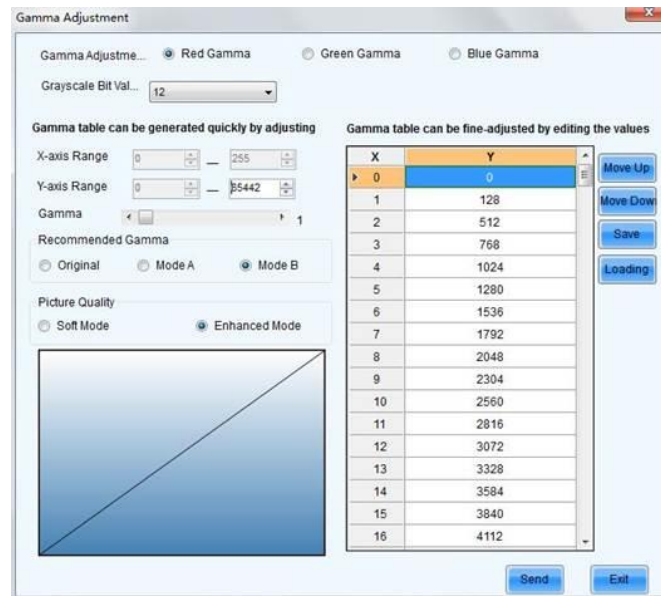

Note:

Dragging the Gamma slider to set the Gamma value will adjust the Gamma curve and Gamma table simultaneously.

- | Move Up: Move the position of the selected value up in the Gamma table.
- | Move Down: Move the position of the selected value down in the Gamma table.
- | Save: Save the current Gamma values as a file.
- | Load: Load a Gamma value configuration file from PC.
- | Color temperature adjustment
 - Rough adjustment: Select **Rough Adjustment** and drag the slider or enter a number to set the color temperature.
 - Precise adjustment: Select **Precise Adjustment** and click  to enter the **Advanced Color Configuration** page. On that page, click **Import** to import a color temperature file, or click **Add** to set the color temperature information.
- | Color space adjustment
 - Disable: Do not enable color space adjustment.
 - PAL/NTSC: Set the color system as PAL or NTSC.

Add configuration: Click  to enter the **Advanced Color Configuration** page to configure the color space parameters. Then, click **Send** and **Save to HW**.

Advanced Adjustment

You can configure multiple time points, each point can be configured with specified brightness or environment brightness.

I **Specified brightness:** The brightness of LED display from certain time on designated by the user, the brightness is fixed.

I **Environment brightness:** The brightness of environment from certain time on designated by the user, the software will automatically adjust the LED display brightness in accordance with the parameters set by the users as well as environment brightness information collected by light sensors so that the LED display can exhibit proper brightness under different environment brightness.

Add specified brightness

Step 1 Click , Set the start time, type of adjustment and designated brightness.

Step 2 Click [More Settings](#), Choose whether to adjust color temperature, if it's needed to adjust color temperature, you can choose color temperature segment in the drop down list (color temperature table must be configured in advance, please see description of color temperature table in **9.5 Advanced Color Configuration**), check **Adjust Gamma**, drag scroll bar to adjust Gamma value.

Step 3 After parameter configuration is done, click , to add another designated brightness.

Add environment brightness

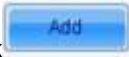
Step 1 Click , to set start time and type of adjustment.

Step 2 Click [More Settings](#), choose whether to adjust color temperature, if it is needed to adjust color temperature, you can choose color temperature segment in the drop down list (color temperature table must be configured in advance, please see description of color temperature table in **9.5 Advanced Color Configuration**), check **adjust Gamma**, drag scroll bar to adjust Gamma value.

Configure light sensors

Environment brightness is detected by light sensors, a system must be equipped with light sensors, and you must configure the light sensor before adding environment brightness.

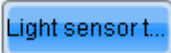
I : Detect light sensors connected to sending cards and function card, the light sensors that connected to function card must be set as the external device.

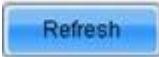
I : Refresh current light sensor connection conditions to avoid new connection or disconnecting the light sensor during operation.

I **When light sensor fails, adjust the brightness to:** Enabled after being checked. If not enabled, when light sensor fails, the brightness will remain at the latest updated brightness value.

 Fast section di...

I : Divide the portion between the maximum environment brightness and minimum environment brightness into designated equal parts, the portion between the maximum and minimum LED display brightness is also divided into similar equal parts. The software will adjust the LED display brightness to corresponding section in accordance with the section of current environment brightness.



Note:

NovaLCT first generates the environment brightness value from measurement results of all available light sensors according to the calculating type. And then NovaLCT uses the generated environment brightness to adjust the LED display brightness according to the parameter settings, such as brightness thresholds, segment numbers.

I **Night Mode**

Night mode is to control screen brightness at night. The night mode is required to be enabled to avoid abnormal screen brightness caused by light sensor that disturbed by external light or by abnormal collection environment brightness data.

In night mode, the system will adjust the screen brightness to the maximum brightness value in night mode while the screen brightness which is adjusted based on the environment data collected through the light sensor is greater than the set maximum brightness value in night mode.

1. Select the check box in front of **Opening** to start the night mode.
2. Click  to add setting items of the night mode including **Start time, End time and Brightness maximum**.
 - Start time: Set the start time for the night mode.
 - End time: Set the end time for the night mode.
 - Brightness maximum: Set the maximum brightness value in night mode.



I Maximum of 4 periods could be set for the night mode, and there cannot be any overlap between every two periods.

I When the night mode is enabled, at least one period must be set.

I When the start time and end time are set to the same time value, night mode is default as the only serving mode all the time.

I The system does not support hardware-based adjustment.

I A selected record could be modified by clicking the  icon.

3. Click **OK** to complete the night mode setting.

Click **Finish** to complete the light sensor setting.

Adjust by Light Sensor

One time point will be generated by NovaLCT automatically, and it will be configured with environment brightness by default.

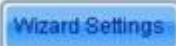
Step 1 Click , check **Adjust by Light Sensor**, then

click .

Step 2 If you have not finished configuration of light sensor, it is need to configure the light sensor then, the detailed operation, please refer to the step 3) in **Advanced Adjustment**.

Step 3 Add specified brightness, ambient brightness as required, or edit or delete the added settings.

All operations are finished, click .

Auto Brightness Time Interval

The following steps are to set the time interval for auto brightness.

Step 1 Click right button on the circled panel icon, as shown below



Step 2 Select **Brightness Advanced Settings** to open the advanced settings window.

Step 3 Set the values for **Detect Period** and **Read times of light sensors**. **Detect Period** is the time period the light sensors measure the environment brightness. **Read times of light sensors** is the times that NovaLCT reads the measurement results of the light sensors. Thus the auto brightness time interval is the production of Detect Period and Read times of light sensors.

For example, if light sensors measure the environment brightness every 10 second (this is the Detect Period.) and NovaLCT reads the measurement results of the light sensors for 5 times (this is the Read times of light sensor.) before adjusting the LED display brightness, the auto brightness time interval will be 50 seconds.



Note:

The default values for Detect Period and Read times of light sensors are 60 seconds and 5 times respectively. Thus the auto brightness time interval is 300 seconds or 5 minutes by default.

9.7 Screen Control



Start NovaLCT and click **Screen Control** to enter the **Screen Control** window.

The Screen Control window

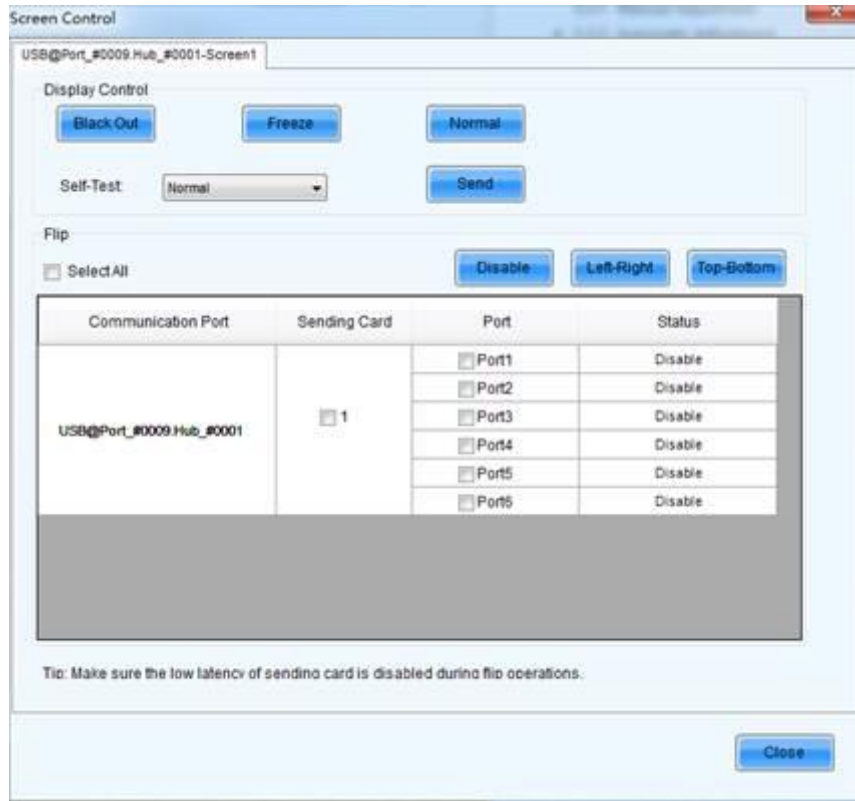

I **Black Out**

Show nothing on the LED display.

I **Freeze**

Always show the current image frame of the LED display.

I **Normal**

Switch the LED display back to normal from Black Out or Freeze.

I **Self Test**

Show the test images generated by the receiving card for LED displays aging test or error detecting.

When the MCTRL660 PRO device is connected, the Flip function is available. You can select a flipping option for the image of the Ethernet port connected to the corresponding sending card. The option can be **Disable**, **Left-Right**, or **Top-Bottom**.

9.8 Check Hardware Information

Select **Settings > Hardware Information** to enter the **Hardware Information** page.

The Hardware Information page

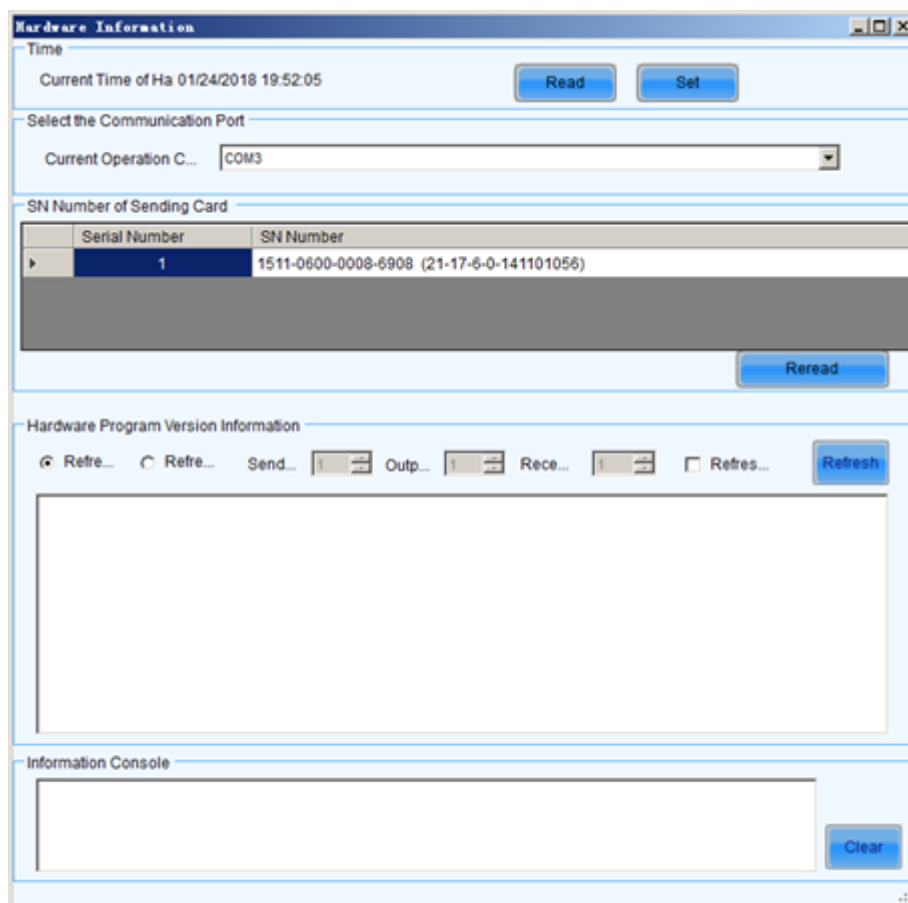

I Current Time of Hardware

This is the date and time of the current synchronous system. Click **Read** button to update the hardware time shown in the **Time** panel. Click **Set** button to set the time of the current synchronous system as that of the computer.



Note:

The date information has been set for the synchronous system when produced. Only time (hour, minute and second) is set here for the synchronous system.

I Current Operation Communication Port

If more than one synchronous system is connected to the computer, set the communication port through which the synchronous system to be configured.

I SN Number of Sending Card

Listed are the SNs of all sending cards of the current communication port. To update the listed SNs, click **Reread**.

I Hardware Program Version Information

Displays the program version information of the sending card MCU, sending card FPGA, and receiving card FPGA.

9.9 Brightness/Color Calibration

Online Calibration

Online calibration is that NovaCLB (calibration software) connect NovaLCT through network for calibration of LED displays.

It supports single-screen mode and combined-screen mode.

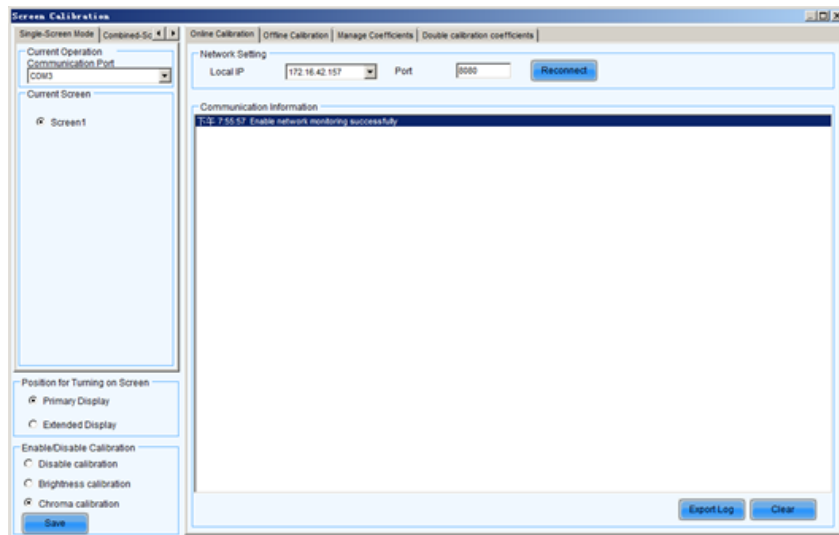

I Current Serial Port

This is the serial port through which the LED display to be calibrated is connected to the computer.

I Current Screen

The LED displays connected to the computer will be list in this panel. Select the LED display to be calibrated from the list.

I Local IP

This is the IP address that NovaLCT listens to. It is actually an IP of the computer on which NovaLCT is running.

I Port

This is the port that NovaLCT listens to.

I Reconnect

Click this button to terminate the current listening process and start a new listen process using the settings of Local IP and Port.

I Communication Log

Records of the communication between NovaCLB and NovaLCT are listed in this panel.

I Enable Calibration

This option is to enable or disable LED display calibration using calibration coefficients.

I Save button in the Enable/Disable Calibration panel

Click this button to save the calibration switch status (enable or disable) to the hardware.

I Save button in the communication log panel

Click this button to save the communication log to a text file.

Coefficients Management

This page is to adjust the calibration coefficients for better calibration performance. The **Manage Coefficients** page is shown below

The Manage Coefficients page

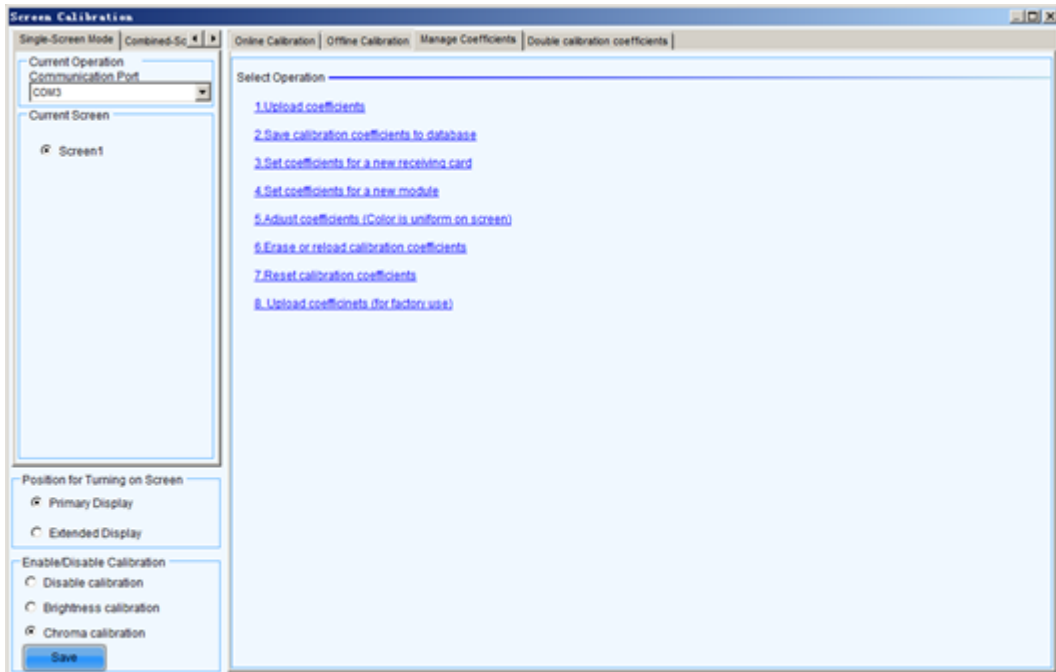

I Upload Coefficients

Upload a calibration coefficients database to the LED display.

I Save coefficients to database

This operation is to read back the calibration coefficients from the LED display and save them to a database file.

I Set coefficients for a new receiving card

This option is to set the calibration coefficients for a newly placed receiving card in the LED display.

I Set coefficients for a new module

This option is to set the calibration coefficients for a newly placed module in the LED display.

I Adjust Coefficients

This option is to adjust the calibration coefficients of the selected LED display area for better performance.

I Erase or reload Coefficients

This option is to erase or reload the calibration coefficients of the selected LED display.

Upload Coefficients

This is to upload the calibration coefficients and Adjust lines coefficients to the LED display thus the LED display control system can use the coefficients to improve the image quality of the display.

Step 1 Browse the directory and choose the files of calibration database and dark or

bright lines.

The page for upload coefficients step 1

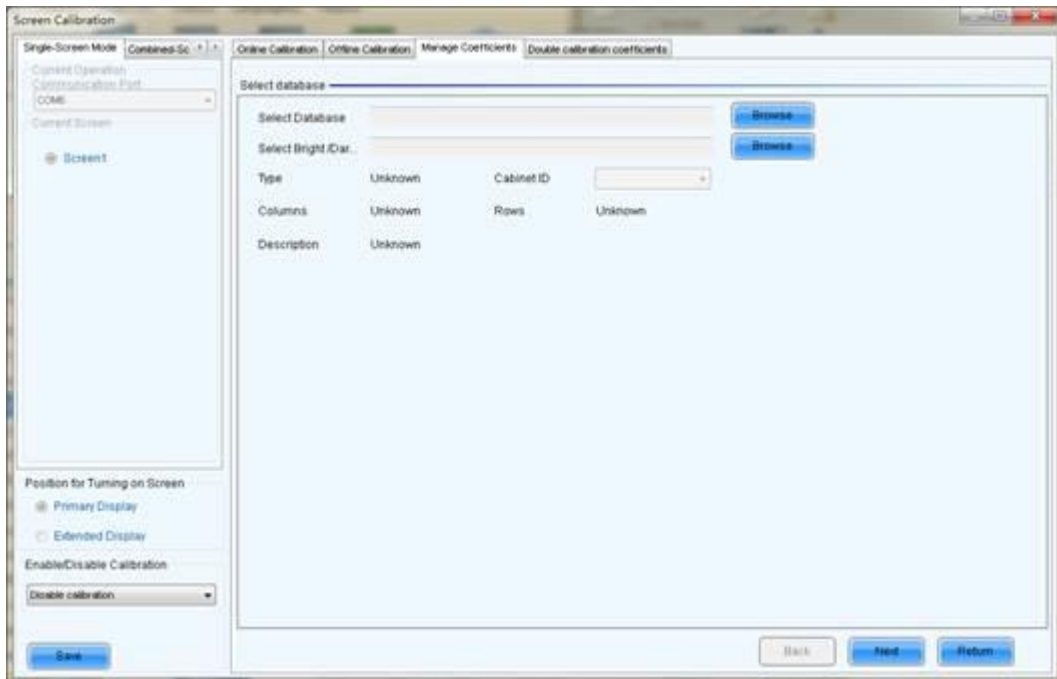

I Browse

Click this button to select the calibration coefficients database file to be uploaded.

I Type

The type of the selected calibration coefficients database is shown here. There are two database types, screen database and cabinet database. A screen database contains calibration coefficients for a whole display while a cabinet database contains calibration coefficients for one or multiple cabinets.

I Cabinet ID

The cabinet ID(s) will be shown here if the selected is a cabinet calibration coefficient database

I Columns

This is the column number of the calibration coefficient array of the selected database.

I Rows

This is the row number of the calibration coefficient array of the selected database.

Step 2 Click **Next** button to open the page for Step 2 after all settings.

This step is to specify the LED display area for which the calibration coefficients are to be uploaded. There are three options, Screen, Pixel, Topology or List.

I Screen

The page for uploading calibration coefficients in Screen way

Select Upload Area

Screen:1 Location:X=0, Y=0 Size:512W×256H

Screen Pixel Topology or List Select Area On Screen

Operate all pixels!

Back Next Return

Detailed description: This is a software interface for uploading calibration coefficients. The title bar reads 'Select Upload Area'. Below the title bar, it displays 'Screen:1 Location:X=0, Y=0 Size:512W×256H'. There are four radio buttons: 'Screen' (which is selected), 'Pixel', 'Topology or List', and a checkbox 'Select Area On Screen'. The main area of the interface is a large light blue rectangle containing the text 'Operate all pixels!' in green. At the bottom right, there are three buttons: 'Back', 'Next', and 'Return'.

I Pixel

The page for uploading calibration coefficients in Pixel way

Select Upload Area

Screen:1 Location:X=0, Y=0 Size:512W×256H

Screen Pixel Topology or List Select Area On Screen

Start Column: 0

Start Rows of: 0

Width: 512

Height: 256

Back Next Return

Detailed description: This is a software interface for uploading calibration coefficients. The title bar reads 'Select Upload Area'. Below the title bar, it displays 'Screen:1 Location:X=0, Y=0 Size:512W×256H'. There are four radio buttons: 'Screen', 'Pixel' (which is selected), 'Topology or List', and a checkbox 'Select Area On Screen'. The main area contains four input fields: 'Start Column' with value 0, 'Start Rows of' with value 0, 'Width' with value 512, and 'Height' with value 256. At the bottom right, there are three buttons: 'Back', 'Next', and 'Return'.

I Topology or List

The page for uploading calibration coefficients in Topology or List way



I Screen

If this option is selected, calibration coefficients for the whole display will be uploaded.

I Pixel

Select this option to upload calibration coefficients to the specified pixel area.

I Topology or List

Selected this option to upload calibration coefficients to the cabinets selected in the cabinet array sketch map or the cabinet list. (If the current LED display is a standard display, the sketch map of the cabinet array will be shown after this option is selected. Otherwise, if the current is a complex display, the show is the cabinet list.)

Step 3 Select **Fast Upload** or **Stable Upload**, and click **Upload**.

The upload calibration coefficients Step 3 page



I Fast Upload

The uploading speed will be set as maximum thus the time required for uploading is minimized if this option is selected.

I Stable Upload

The uploading process is more stable and reliable for this option. But the time required is longer than the Fast Upload option.

I Upload

Click this button to upload the selected calibration coefficients to the hardware.

I Save

Save the selected calibration coefficients to hardware (FLASH). The saved data won't be lost even the system is powered off.

Save Coefficients to Database

This operation is to read back the calibration coefficients from the current LED display and save them to a database file.

Step 1 The calibration coefficients read back can be saved to an existing database or a new database. Shown as below which are the pages for saving coefficients to an existing database and a new database respectively.

The page for saving calibration coefficients to an existing database

Select Database

Save to an Existing Database Save to a New Database

Select Database:

Type: Unknown Existing Cabinet ID:

Column: Unknown Rows: Unknown

Discription: Unknown

Open

Click this button to open an existing database to save the read back calibration coefficients. The new saved coefficients will replace the old ones according to the position. If the coefficients array size of the opened database is smaller than that of the current display, the save operation will be failed. If the opened is a cabinet database, the ID list of the existing cabinets of the database will be shown.

The page for saving calibration coefficients to a new database

I Screen-Database

Select this option if it is to save the calibration coefficients to a new screen database.

I Cabinet-Database

Select this option if it is to save the calibration coefficients to a new cabinet database.

I Create

Click this button to create a new screen database or a cabinet database according to the settings.

	<p>Note:</p> <ul style="list-style-type: none"> Screen database: In a screen database, the saved are the calibration coefficients and the positions of they are to be uploaded to in the LED lights array of the whole display. In the uploading procedure, the coefficients are uploaded according to the positions set for them. Thus if the position of a cabinet is changed, the coefficients for this cabinet will not be correctly uploaded. Cabinet database: In a cabinet database, the calibration coefficients are arranged in the form of cabinets. The coefficients for the same cabinets are grouped together and labeled with the cabinet ID. Thus even the place of a cabinet has been changed, the corresponding coefficients can also be correctly uploaded to the cabinet.
---	---

Step 2 Select the display area for which the calibration coefficients are to be saved to a database.

The page for specifying the display area for coefficients saving



I Screen

Check this option if the calibration coefficients for the whole display are to be saved. If the database for saving the coefficients is a cabinet database, this option will be unavailable.

I Pixel

Check this option to select the pixel area for which the calibration are to be saved. If the database for saving the coefficients is a cabinet database, this option will be unavailable.

I Topology or List

Check this option to select the cabinets for which the calibration coefficients are to be saved. Note that if the database for saving the coefficients is a cabinet database, one cabinet should be selected at one time for coefficients saving.

I Save

Click this button to save the calibration coefficients of the selected display area to the specified database. If the database for saving the coefficients is a cabinet database, a dialog will appear for users to input the cabinet ID.

I Maintain (Only full-screen support):

The software saves by cabinet, supports maintaining, namely when network or other problems occur and cause saving suspended, select maintain to continue saving from the cabinet having error.

Set coefficients for a new receiving card

Step 1 Specify the LED display area that the new receiving card works for. Shown as below which is the page for specifying the area.

The page for specifying the working area of the new receiving card



Step 2 Select the calibration coefficient source. The coefficients could be from a database (the **Database** option) or generated according to those of the surrounding receiving cards (the **Refer to Surrounding Scan Board** option).

The page for getting calibration coefficients from a database

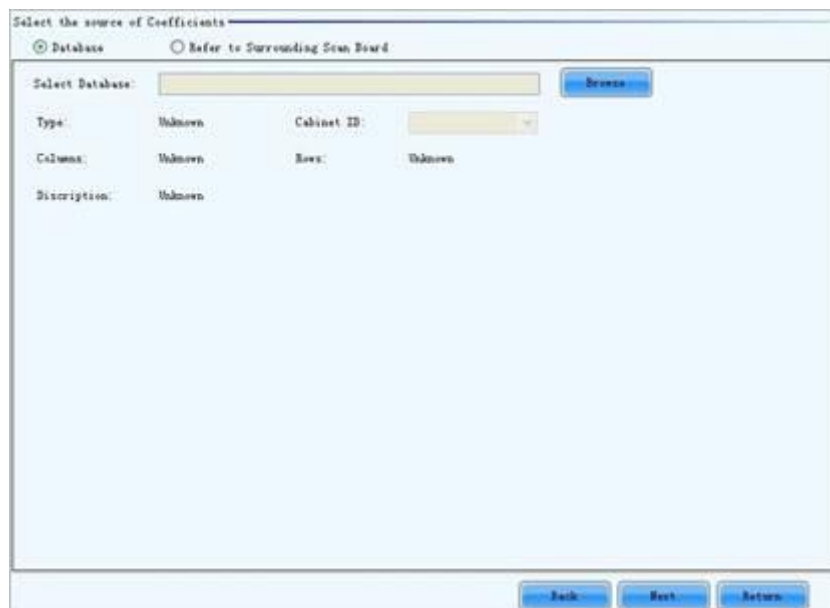

I Browse

Click this button to select the database that the calibration coefficients for the new receiving card are from. If the selected is a cabinet database, the cabinet ID should also be specified from the Cabinet ID drop list.

I Cabinet ID

If the selected database is a cabinet database, the IDs of the cabinets of which the calibration coefficients are contained in the database will be list in the drop list. If the selected database is a screen database, the list will be unavailable.

Figure 1-3 The page for generating coefficients for the new receiving card according to those of its surrounding receiving cards

Select the source of Coefficients

Database Refer to Surrounding Scan Board

Select Reference Cabinet

Reference Zone: 1

Adjusted Cabinet: [Yellow Square] Reference Cabinet: [Cyan Square]

[Back] [Next] [Return]

Note:



- I One or more surrounding cabinets can be selected for generating the calibration coefficients for the new receiving card.
- I The calibration coefficients are generated according to those of the selected surrounding cabinets and make the cabinet driven by the new receiving card similar to its surrounding cabinets in brightness, hue and saturation. The generated calibration coefficients are just substitution of those from NovaCLB and are not as good as those from NovaCLB in performance.

Step 3 If the calibration coefficients from Step 2 are not satisfying, they can be adjusted. There are two type of adjustment, Simple and Advanced.

The Simple adjustment page

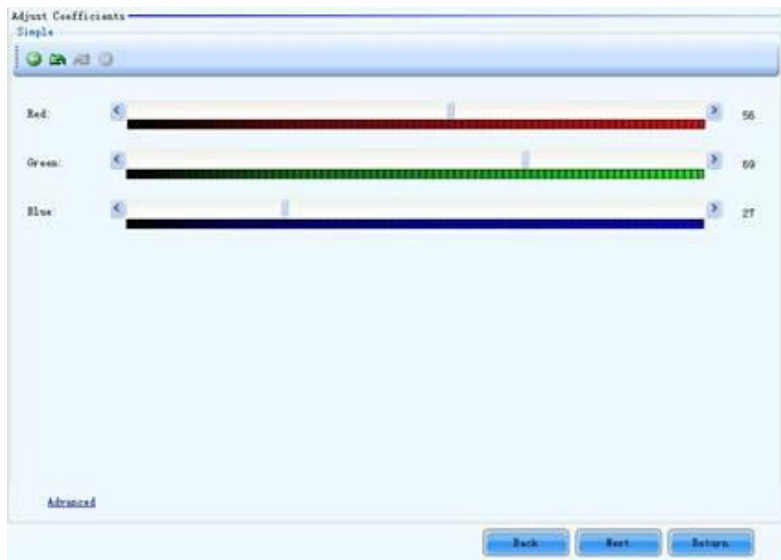

I Red

Use the slide bar to adjust the red brightness of the calibration coefficients.

I Green

Use the slide bar to adjust the green brightness of the calibration coefficients.

I Blue

Use the slide bar to adjust the blue brightness of the calibration coefficients.

I Advanced

Click this item to switch to the advanced adjustment page.

The Advanced adjustment page

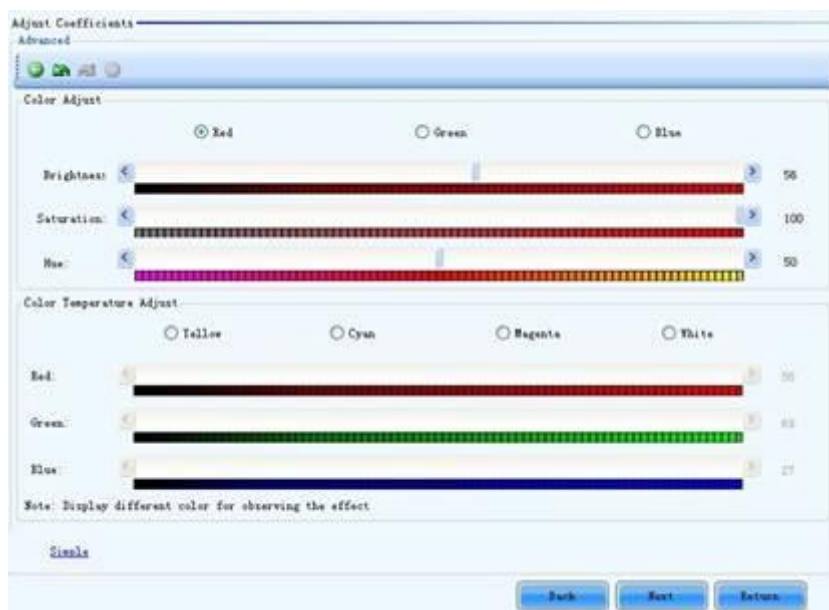

I Color Adjustment

The brightness, hue and saturation of red, green and blue can be adjusted in the **Color Adjust** panel.

I Color Temperature Adjustment

Use the slide bars to adjust the red, green and blue components for yellow, cyan, magenta and white in the Color Temperature Adjust panel.

I Simple

The color bar under each side bar indicates the color to be shown when adjusting.

	<p>Note:</p> <ul style="list-style-type: none"> If the cabinet driven by the new receiving card is only different from the surrounding cabinets in brightness, simple adjustment is sufficient. If the cabinet driven by the new receiving card is different from the surrounding cabinets in color, adjust the brightness, saturation and hue through the advanced adjustment page for better image quality. Use the test tools in Plug In Tool >Test Tool to require the LED display to show the color that is being adjusted.
---	---

Step 4 Save the calibration coefficients to the hardware (FLASH) so they won't be lost when the LED display is powered off.

The page for saving calibration coefficients to the hardware



Save

Save the coefficients to the hardware.

Set coefficients for a new module

Step 1 Specify the cabinet which the new module is in.

The page for specifying the cabinet which the new module is in



Step 2 Double click the selected cabinet, and select the new module.

The page for specifying the new module

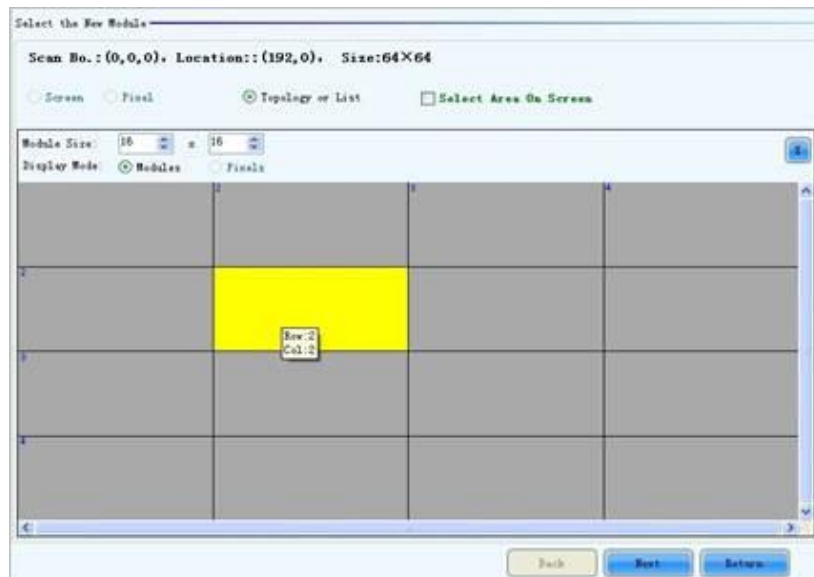

Module Size

Set the pixel array size of a module here. NovaLCT divides a cabinet into modules according to the module pixel array size and the cabinet pixel array size.

Step 3 Select the calibration coefficients source. Calibration coefficients generated

according to those of the surrounding modules are used for the new module because the coefficients saved in the receiving card or the database are not suitable for the new module.

The page for selecting the calibration coefficients source

The screenshot shows a window titled "Select the source of Coefficients". It has a radio button selected for "Refer to Surrounding Modules". Below this, there is a section "Select Reference Module" with a "Reference Zone" input field containing the number "1" and minus/plus buttons. There are also "Adjusted Module:" and "Reference Module:" labels with corresponding colored squares (yellow and cyan). A large grid area shows a 3x3 grid of pink squares with a yellow square in the center. At the bottom, there are "Back", "Next", and "Return" buttons.

	<p>Note:</p> <ul style="list-style-type: none"> One or more surrounding modules can be selected for generating the calibration coefficients for the new module. The calibration coefficients are generated according to those of the selected surrounding modules and make the pixel array driven by the new module card similar to its surrounding in brightness, hue and saturation. The generated calibration coefficients are just substitution of those from NovaCLB and are not as good as those from NovaCLB in performance.
---	---

Adjust Coefficients

If some parts of the LED display are different from the rest in color, the color of these areas can be adjusted by modifying the corresponding calibration coefficients.

Step 1 Select the areas to be adjusted.

The page for selecting the area to be adjusted



Step 2 Select the adjustment type. If Adjust Own Effect option is selected, the color adjustment of selected area is independent to the other areas of the LED display. If **Effect As Other Selected Area** option is selected, the color of the selected area will be adjusted according to the reference area color. The selected area color will look similar to the reference area color after the adjustment operation.

The page for Adjust Own Effect option



The page for Effect As Other Selected Area

The screenshot shows a software interface for selecting an adjustment mode. At the top, under 'Select The Adjustive Mode', there are two radio buttons: 'Adjust Own Effect' (unselected) and 'Effect As Other Selected Area' (selected). Below this is the 'Select Reference Area' section, which displays 'Screen:1 Location:X=100, Y=100 Size:256W×128H'. There are four radio buttons: 'Screen' (unselected), 'Pixel' (unselected), 'Topology or List' (selected), and 'Select Area On Screen' (unselected). The main area contains a 2x4 grid of colored squares with coordinates: (1,1) is yellow, (1,2) is pink, (1,3) is pink, (1,4) is pink, (2,1) is pink, (2,2) is pink, (2,3) is pink, and (2,4) is pink. To the right of the grid is a vertical 'Zoom' slider with a value of 1.0. At the bottom are three buttons: 'Back', 'Next', and 'Return'.

	<p>Note:</p> <p> If Adjust Own Effect option is selected, NovaLCT will acquire the calibration coefficients of the selected area for the hardware. Adjustment on these coefficients is independent to the other area of the LED display.</p> <p> If Effect As Other Selected Area is selected, NovaLCT will adjust the calibration coefficients of the selected area according to those of the reference areas and make the selected area looks similar to the reference areas in color. The nearer the reference areas are to the area being adjusted, the better the adjustment result will be.</p>
---	--

Step 3 Click the **Save** button to save the adjusted calibration coefficients to the hardware. The save coefficients won't be lost even the system is powered off.

The page to save the calibration coefficients

The screenshot shows a simple interface titled 'Apply and Save Coefficients'. It features a blue 'Save' button in the top right corner. Below the button, there is a link that says 'Apply The Effect To Other Area'. At the bottom of the page are three buttons: 'Back', 'Finish', and 'Return'.

Apply The Effect To Other Area

The adjustment operations in Step 2 and Step 3 can also be applied to other areas that need the same adjustment.

The page for Apply The Effect To Other area

Apply and Save Coefficients

Apply The Effect To Other Area

Apply the Effect to Other Area ..

Screen:1 Location:X=100, Y=100 Size:256Wx128H

Screen Pixel Topology or List Select Area On Screen

Operate all pixels!

Apply

Back Finish Return

Apply

Apply adjustment operations to the selected area.



Note:

If the adjustment operations are to be applied to another area, the problem of this area should be similar to the area selected in Step 1. Otherwise, don't apply the operations to this area.

If the adjustment result of the new area is satisfying after applying the operations, click **Save** button again to save the adjusted calibration coefficients to the hardware.

Erase or Reload Coefficients

- I **Erase coefficients:** erasing calibration coefficients of the whole display or any cabinets.
- I **Reload coefficients:** reload the calibration coefficients lastly saved in hardware.

The page for erasing calibration coefficients

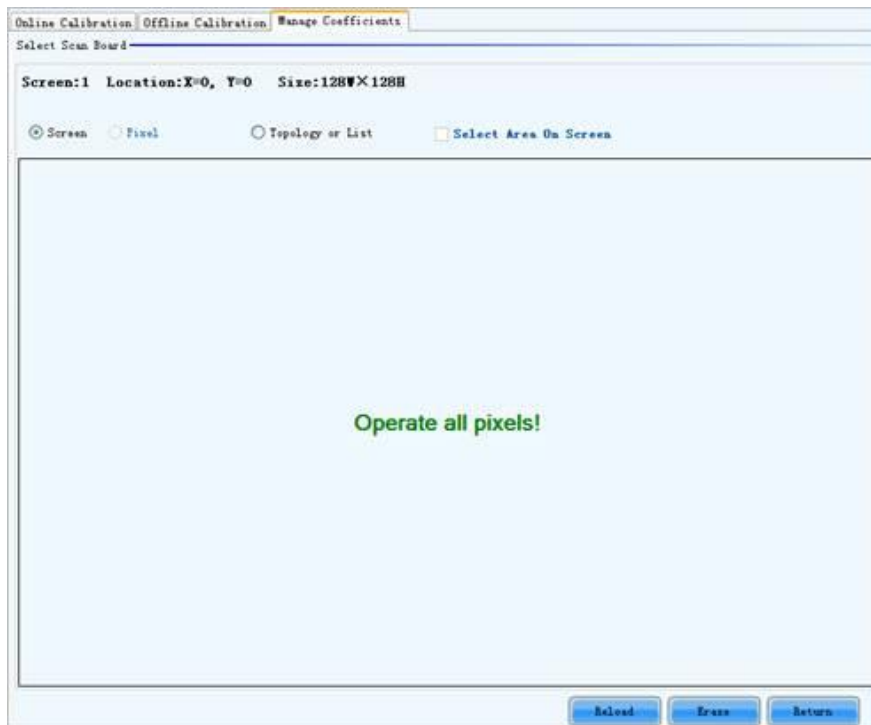

I **Screen**

Select this option to erase all calibration coefficients for the whole display.

I **Topology or List**

Select this option to select the cabinets from the cabinet array sketch or the cabinet list of which the calibration coefficients are to be erased.

	<p>Note: The calibration coefficients will be their default values after the erase operation. Make a copy of the calibration coefficients (save to a database file) for safety.</p>
---	--

Resetting Calibration Coefficients

Set the calibration coefficients again for the screen or a specified area according to the module size or pixels.

After all the coefficients are reset, click **Save to HW** so that the coefficients can take effect.

Resetting calibration coefficients

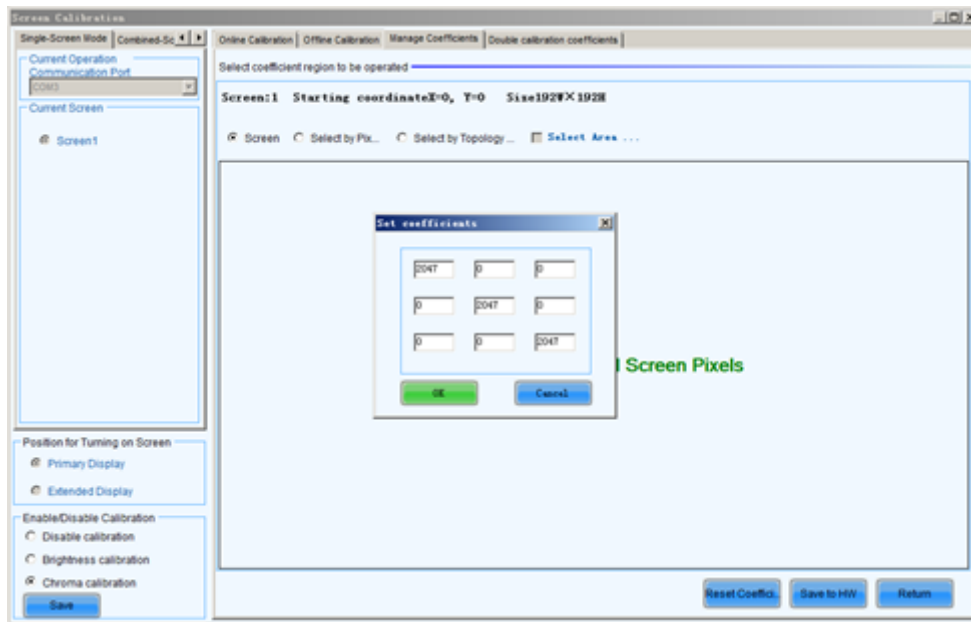

9.10 Hardware Monitoring

NovalCT supports monitoring status of sending cards, receiving cards and monitoring cards, as well as temperature, humidity, smoke, fan, power supply, ribbon cable, cabinet door and smart module. NovalCT is applicable to both ordinary screen and combined screen.



Click **Monitor** to enter the monitoring interface, as shown in below.

The Monitor page

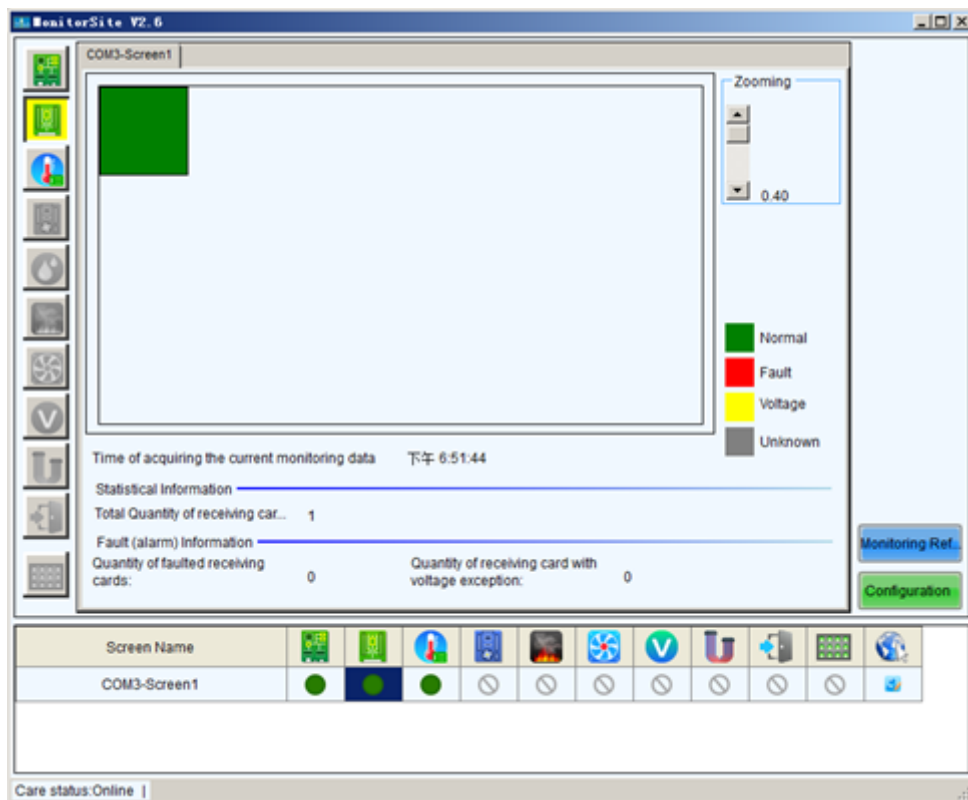

I Monitoring Refresh

This button is used to update the monitored data.

I Configuration

This button is used to edit the contents to be monitored and set rules for alarm.

Refresh Period

Modify refresh period and reread times when reading the status failed at the refresh period interface, wherein the period is the period of refreshing the monitoring data.

If all screens are registered to the NovaCare server, check “Automatic Refresh” to perform remote monitoring.

Refresh period

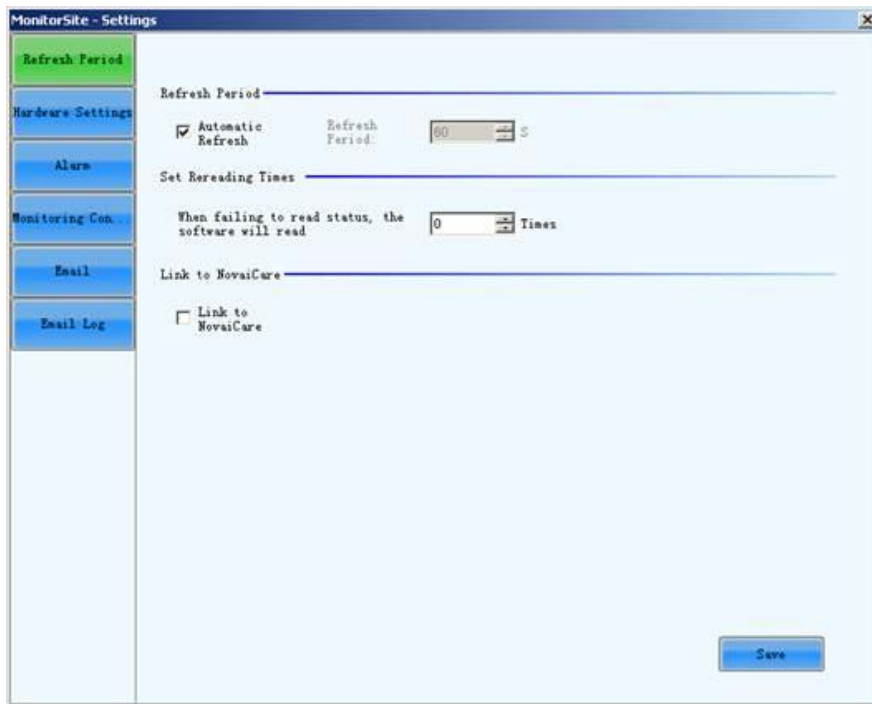

The screenshot shows a window titled "MonitorSite - Settings" with a sidebar on the left containing buttons for "Refresh Period", "Hardware Settings", "Alarm", "Monitoring Con.", "Email", and "Email Log". The "Refresh Period" section is active and contains the following settings:

- Refresh Period:** A horizontal line with a "Refresh Period" label and a numeric input field set to "60".
- Automatic Refresh:** A checked checkbox labeled "Automatic Refresh".
- Set Rereading Times:** A horizontal line with a label "When failing to read status, the software will read" and a numeric input field set to "0" followed by the text "Times".
- Link to NovaiCare:** A horizontal line with a label "Link to NovaiCare" and an unchecked checkbox labeled "Link to NovaiCare".

A "Save" button is located at the bottom right of the window.

I Auto Refresh

If this option is checked, NovaLCT will automatically check the status and parameters being monitored and update the monitored data periodically according to the period setting.

I Retry times after read status failed

This parameter determines how many times NovaLCT will retry to check the status and parameters being monitored when it fails in doing so.

I Link to NovaiCare

Selecting this option can link NovaLCT to NovaiCare cloud-based monitoring software.

Hardware Configuration

The hardware configuration interface provides all hardware monitoring related setting options. The monitoring functions can only be realized by using the monitoring card, so **Connect to Monitoring Card** option should be selected before the refresh-related options are set.

Hardware configuration

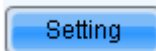

: Click to enter the advanced setting of monitor, as shown in the figure below.

Advanced settings of monitoring

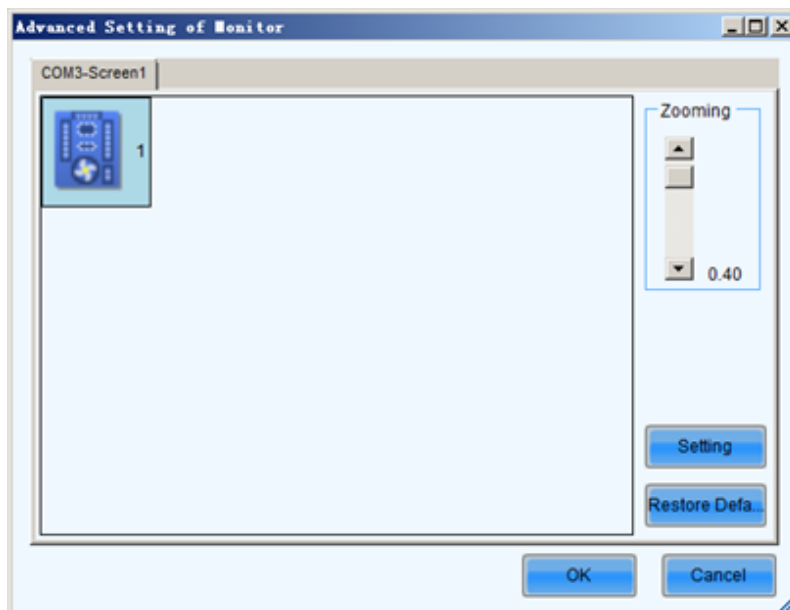

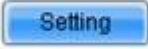
Each receiving card is connected with one monitoring card by default. Click  to pop up with the interface below. Please set the number of receiving cards (0 or 1) according to the actual situation.

Click  to restore the default values immediately.

I Connect to Monitoring Card

If this option is selected, the monitoring data of the monitoring card will be displayed. The **Connect to Monitoring Card** and **Connect to Smart Module** options cannot be selected at the same time.

I Connect to Smart Module

If this option is selected, the monitoring data of the smart module will be displayed. The **Connect to Monitoring Card** and **Connect to Smart Module** options cannot be selected at the same time.

I Refresh Humidity

If this option is selected, the humidity within the cabinets will be under monitoring.

I Refresh Smoke

If this option is selected, the smoke within the cabinets will be under monitoring.

I Refresh Ribbon Cable

If this option is selected, the status of the ribbon cable will be under monitoring.

I Refresh status of Cabinet-Door

If this option is selected, the open/close status of the cabinet doors will be under monitoring.

I Refresh Fan

If this option is selected, the fans status will be under monitoring.

– Set fan quantity uniformly: If for every cabinet, the number of fans to be monitored is the same, select this option and set the fan number in the box to the right of this option.

– Set fan quantity individually: If the numbers of fans to be monitored are different from one cabinet to another, select this option and click the **Setting** button to set the fan numbers for each cabinet.

I The numbers of power supplies on each monitoring card are equal to each other

If this option is selected, the power supplies on the monitor board will be under monitoring.

– Every monitoring card has the same number of power supply: If for every monitor board, the number of power supplies to be monitored is the same, select this option and set the power supplies number in the box to the right of this option.

Set power supply quantity individually is separately set on every monitoring card: If the numbers of power supplies to be monitored are different from one monitor board to another, select this option and click the **Setting** button to set the power supplies numbers for each cabinet.

Alarm Configuration

Display alarm or fault information when setting the temperature, humidity, fan speed and voltage critical value.

Data alarm configuration

The screenshot shows the 'MonitorSite - Settings' window with the 'Alarm' tab selected. The 'Select Screen to Configure' dropdown is set to 'COM3-Screen1'. The configuration includes four conditions:

- When the temperature > 60 °C, show alarm information. [Fahrenheit degree](#)
- When the rotation sp... < 1000 r/m, show alarm information.
- When the voltage < 3.8 V, show alarm information.
- When the voltage < 3.4 V, show fault information.

A note at the bottom states: "Note: Defaults of full-screen configuration come from the first configuration, and later modification on single screen does not affect the full-screen information." A 'Save' button is located at the bottom right.

Control Configuration

Set the rules for auto temperature and smog control.

Control configuration

The screenshot shows the 'MonitorSite - Settings' window with the 'Monitoring Control' tab selected. The 'Select Screen to Configure' dropdown is set to 'COM3-Screen1'. The 'Control Information List' is currently empty. Below the list are buttons for 'Add', 'Edit', 'Delete', 'Clear list', and 'OK'.

Control type	Condition
--------------	-----------

Click  to add control information.

Email Setting



Operation procedures

Select the **Enable Email Notification** option to show the related configuration items as shown below

Email setting

The screenshot shows the 'MonitorSite - Settings' window with the 'Email' tab selected. The interface includes a left sidebar with navigation buttons: Refresh Period, Hardware Settings, Alarm, Monitoring Control, Email (highlighted), and Email Log. The main content area contains the following settings:

- Enable Email Notification: Send email when same fault/a... 3 Times sending ...
- Enable System Recovery Notification
- Enable Sending System Report Email: Send system report email regularly
- Email Sender** section:
 - Email Address: technovastar@vip.163.com
 - Port: 25
 - SMTP Server: smtp.vip.163.com
 - SSL Encryption: Enable
 - Buttons: Modify Sender, Use Default
- Recipient** section:
 - Table with columns: Name, Email address
 - Three empty rows with edit/delete buttons on the right.
- Email Information** section:
 - Sending Email ...: A-1 (e.g., Neighborhood A, Square B)
- Tip: If the display has been registered with NovaiCare, please disable local Email notification, so as not to ...
- Save button

-  : Add the receiver.
-  : Edit the receiver.
-  : Delete the receiver.

If email notification is desired, information related to the email sender, receiver and email is required to be set. If **Enable Sending System Report Email** is selected, click **Send system report email regularly** to set a sending date.

Email Log

If the **Enable Email Notification** option is selected, you can click **Email Log** to view the email notification log history as shown in the following figure.

You can search the logs by time and delete the undesired ones.

The History window for notification emails checking

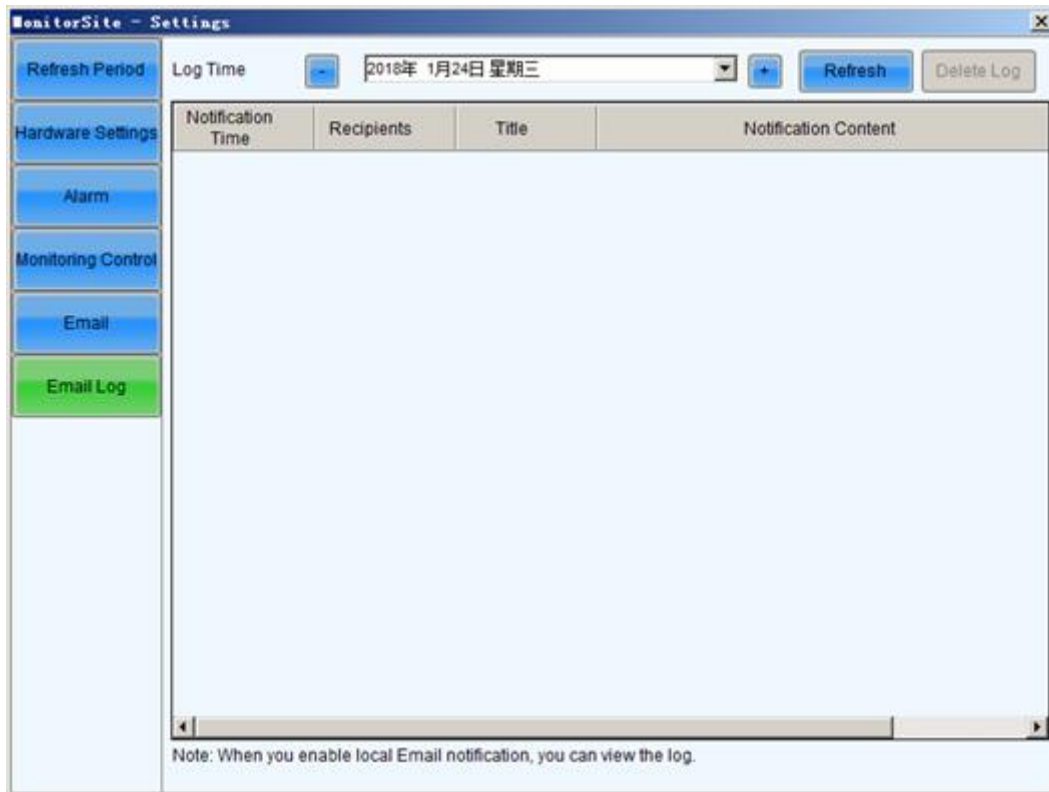

The details of operation for NovaLCT, please refer to the read as shown below:

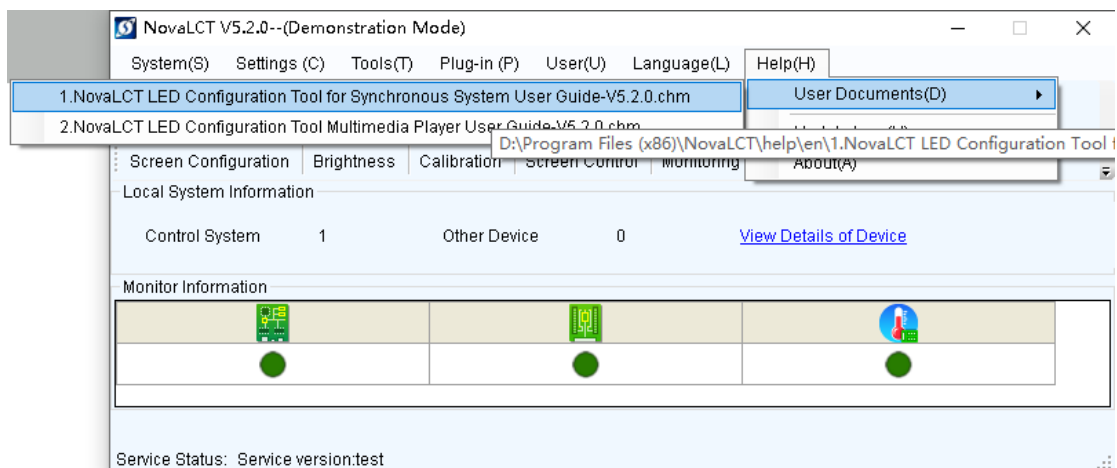

Note: Until now, the monitoring card only support  sending card status,

 receiving card status and  cabinet inside temperature detection.

10. Servicing

10.1 Cleaning

For outdoor LED display screen

Due to outdoor use the LED display screen are exposed to all kinds of weather conditions.

Sand, dust, smog and other dirty things on the LED display and because of that the performance of the LED display may be effected, So regular cleaning on LED display is recommended.

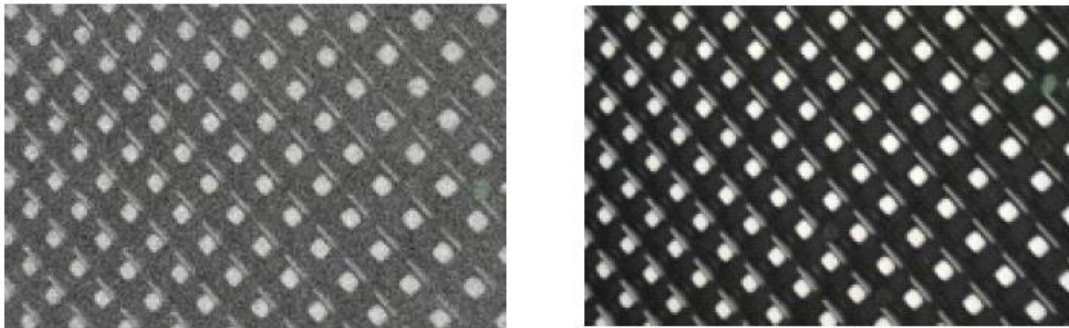

LED`s and shades covered with dirt Clean LED`s and shades

Clean all the cabinets of the LED display screen to avoid brightness differences between cleaned and unclean cabinets.

Necessary tools

Vaporizer with cleaning detergent

Soft hand brush with long hair (recommended 4 cm pork hair)

Garden hose with a spray nozzle

Air compressor

Cleaning steps

1. Seal up the data and power sockets using a power and data linking cable. Make sure that all plug holder clamps are locked firmly.
2. Put the detergent on the shades and LED`s part by part of the LED display screen.
Do not use industrial grease removers. Use only materials or chemicals that are inert, non-corrosive and non-marking.
3. Brush down all the dirt of the LED`s and the shades using a soft hand brush. Do not use a hard bristled brush.
4. Wash away the remaining soap with plenty of fresh water.
5. Repeat from step two until the part is clean.
6. Dry the surface with air compressor.
7. Clean the LED display screen from top to bottom.

10.2 Calibration

Factory calibration

In order to achieve color uniformity among all cabinets of the same display the cabinets can be color calibrated to improve display effect of the LED display screen. The manufacturer can do calibration before goods are delivered out of factory.

Site calibration

When the LED display screen is running for a long time, for example for one year, some part of the display screen may play a different image from other parts. Chromatic aberration will appear on the LED display screen. Then a site color calibration is needed to achieve color uniformity among all cabinets of the LED display screen, please contact Sales & Service for further details.

10.3 Replacement steps

Front Service: Module

Power off the cabinet where the module is in

Remove the module from front by front service tool as shown below



Remove the DC power cable and flat cable from the bad module, and then take off the bad module from cabinet by hand as shown below

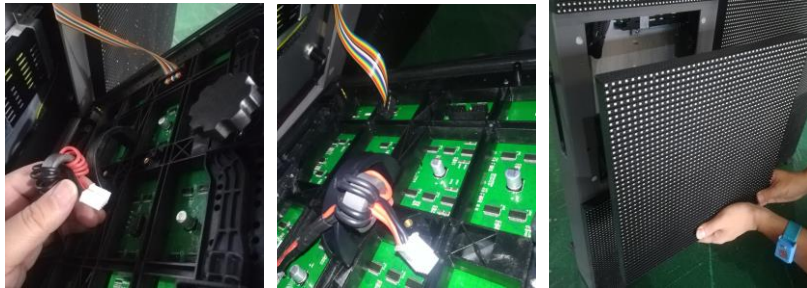

Bring a new module, connect the DC power cable and flat cable into the new module

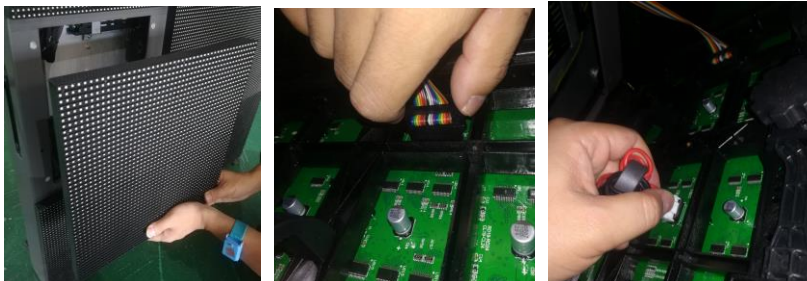

Put the new module on the cabinet and then install it into cabinet by front service tool as shown below



Power on the cabinet.

After replacing modules, the customer should update the calibration data for that module in the receiving card. Operation details are shown in chapter 9.9. All the spare module have a serial number as S-1, S-2, S-3 etc.

Power supply

Power off the cabinet where the power supply is in

Remove the modules from front by front service tool as the modules service steps as shown “Module replacement”

Take off all the cables connected to the power supply as shown below

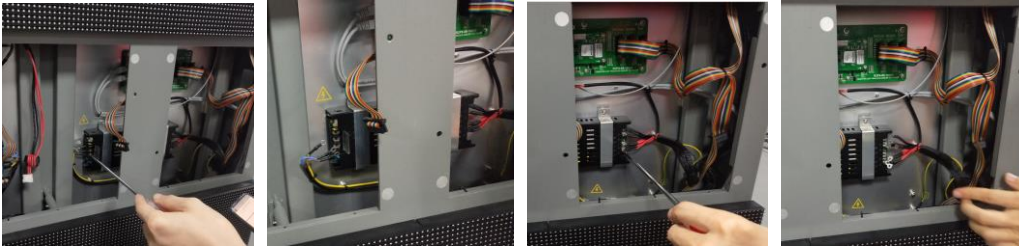

Remove the patching board by screwdriver and then remove the bad power supply from the cabinet as shown below



Install the spare power supply into the cabinet and then install the patching board by screwdriver as shown below

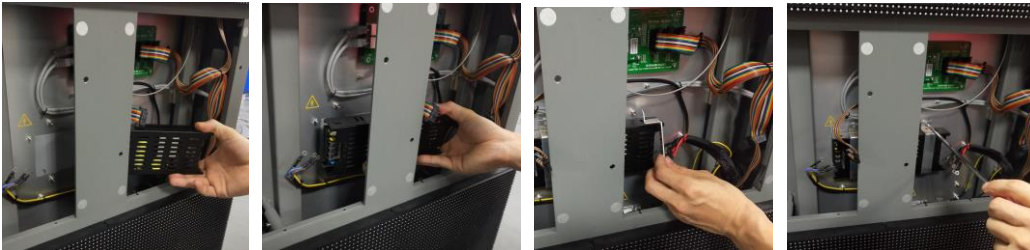

Install all the cables connected to the power supply as shown below.



Install back the modules from front by front service tool as the modules service steps as shown “Module replacement”

Turn on the cabinet.

HUB board

Power off the cabinet where the HUB board is in.

Remove the modules from front by front service tool as the modules service steps as shown “Module replacement”

Remove the bad HUB board from the cabinet as shown below

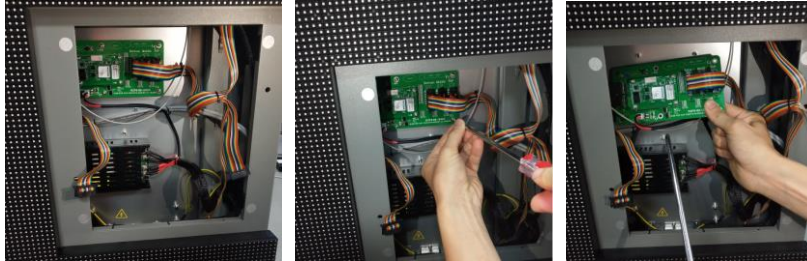

Take off all the cables from bad HUB board and remove receiving card from HUB board as shown below

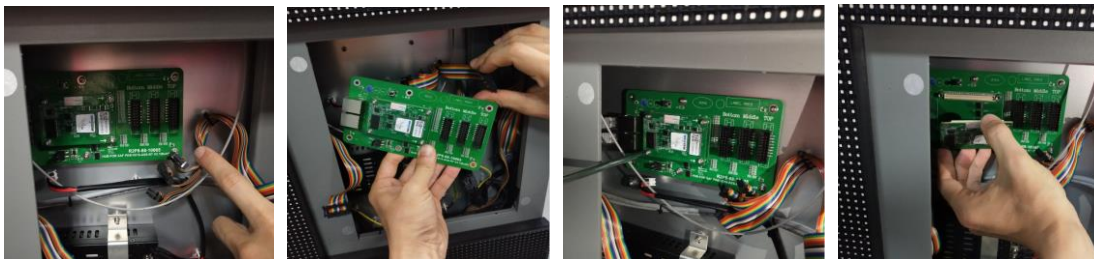

Bring a new HUB board and install back the receiving card, then connect back the cables as shown below



Install the new HUB board on the door of the cabinet as shown below



Install back the modules from front by front service tool as the modules service steps as shown “Module replacement”

Turn on the cabinet.

Receiving card

Power off the cabinet where the receiving card is in.

Remove the modules from front by front service tool as the modules service steps as shown “Module replacement”

Remove the HUB board from front by screwdriver as HUB board service steps as shown “HUB board replacement”

Remove the bad receiving card as shown below.

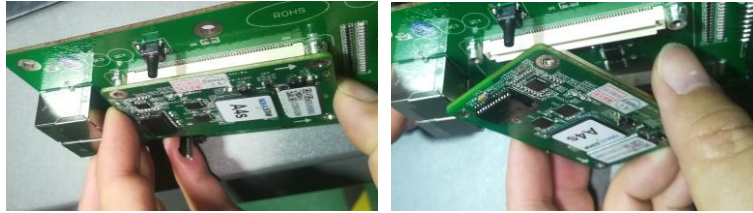

Bring a new receiving card and install it into the HUB board as shown below

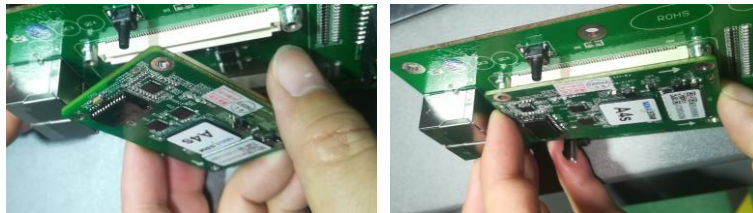

Install back the HUB board from front by screwdriver as HUB board service steps as shown “HUB board replacement”

Install back the modules from front by front service tool as the modules service steps as shown “Module replacement”

Turn on the cabinet.

Open/Close Air switch

Remove the modules from front by front service tool as the modules service steps as shown “Module replacement”

Open/Close Air switch as shown below

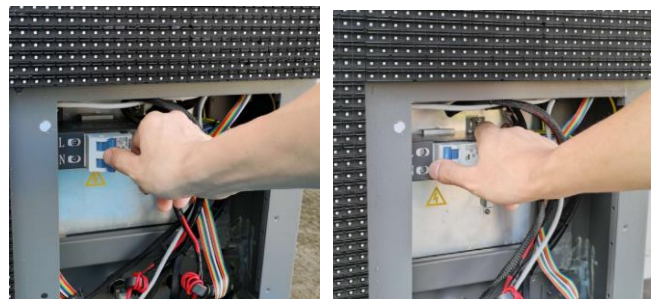

Install back the modules from front by front service tool as the modules service steps as shown “Module replacement”

Air switch

Power off the cabinet where the bad air switch is in,

Remove the modules from front by front service tool as the modules service steps as shown “Module replacement”

Remove the cover for the air switch , take off all the cables on the bad air switch, and then remove the it from the cabinet as shown below

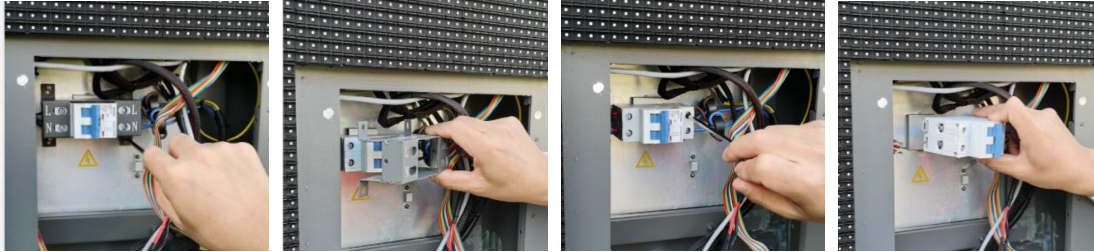

Bring a new air switch and install it into the cabinet, install all the cables into the new air switch, and then install the cover back on the cabinet as shown below

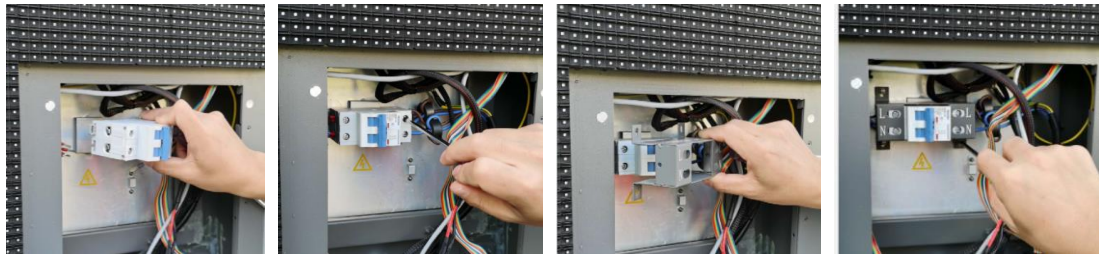

Install back the modules from front by front service tool as the modules service steps as shown “Module replacement”

Power on the cabinet.

Power cascade cable and Signal cascade cable

Power off the cabinet where the bad cables are in.

Remove the modules from front by front service tool as the modules service steps as shown “Module replacement”

Open the door of the cabinet by screwdriver from front as shown below.

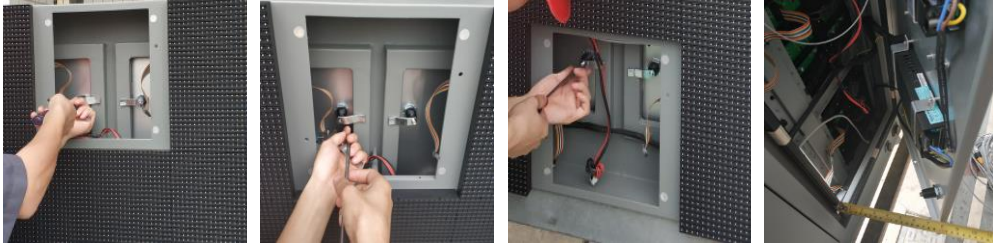

Service the bad cables as shown below



After cables service , close the door of the cabinet as shown below



Install back the modules from front by front service tool as the modules service steps as shown “Module replacement”

Power on the cabinet.

Back Service:

Open cabinet

Before replace the bad parts in cabinet, you need to open the back door of cabinet by key as shown below



Before you replace the electrical parts, please wear the ESD protection gloves first.

Module

Power off the cabinet where the module is in

Remove the module from back by hand as shown below

Remove the DC power cable and flat cable from the bad module, and then take off the bad module from cabinet by hand as shown below

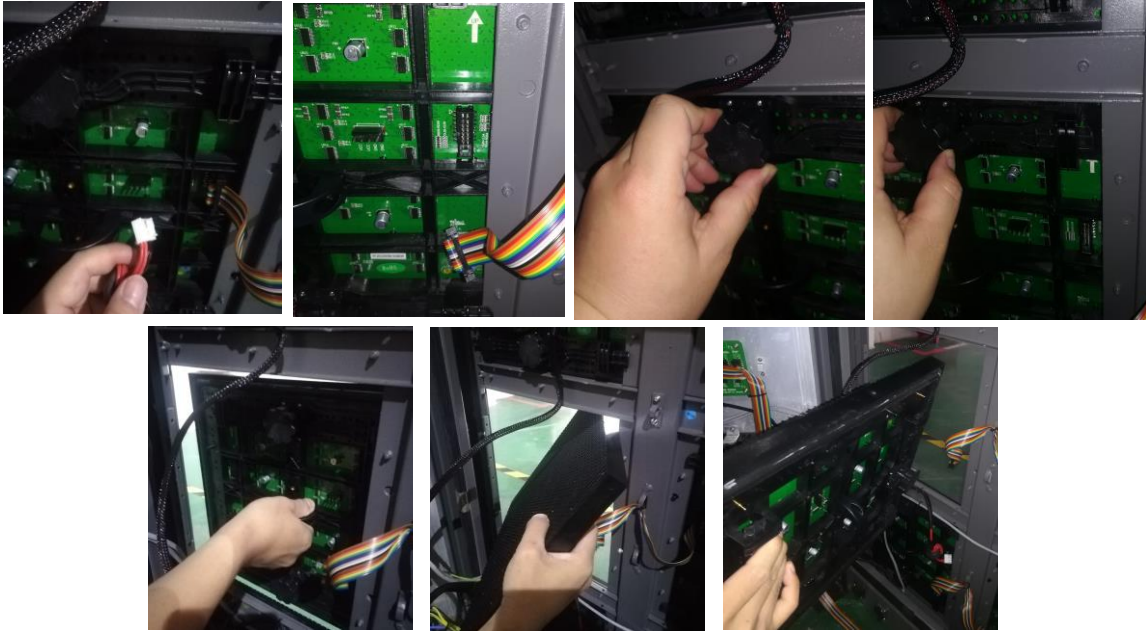

Put the new module on the cabinet and then install it into cabinet as shown below



Connect the DC power cable and flat cable into the new module as shown below

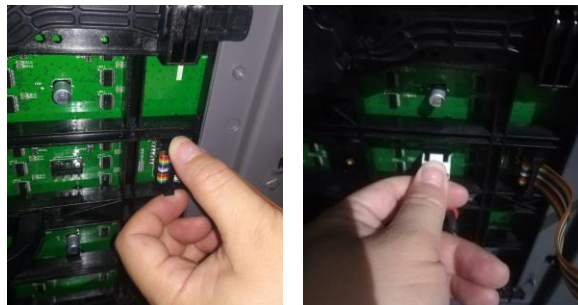

Power on the cabinet.

After replacing modules, the customer should update the calibration data for that module in the receiving card. Operation details are shown in chapter 9.9. All the spare module have a serial number as S-1, S-2, S-3 etc.

Notice: After change modules, must check if the lock is fine as shown below:

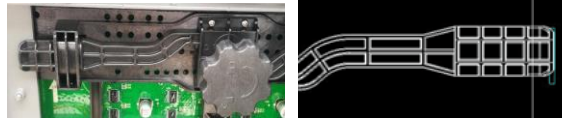

Power supply

Power off the cabinet where the power supply is in

Take off all the cables connected to the power supply as shown below



Remove the patching board by screwdriver and then remove the bad power supply from the cabinet as shown below



Install the spare power supply into the cabinet and then install the patching board by screwdriver as shown below



Install all the cables connected to the power supply as shown below.

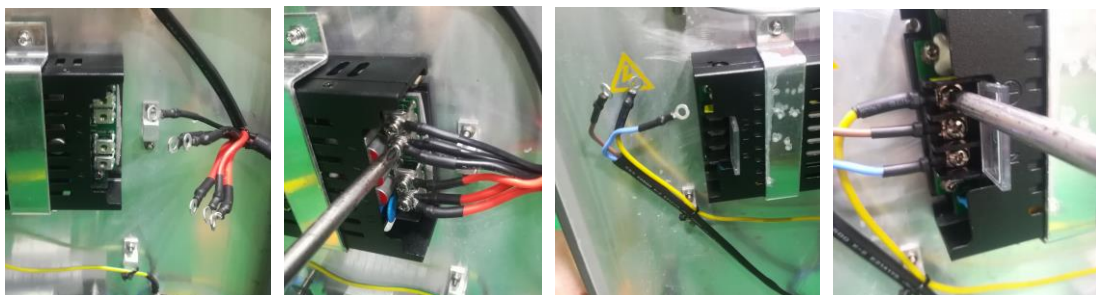

Turn on the cabinet.

HUB board

Power off the cabinet where the HUB board is in,

Take off all the cables from bad HUB board as shown below



Remove the bad HUB board from the cabinet and then remove the receiving card from the bad HUB board as shown below



Bring a new HUB board and install the receiving card into the new HUB board, and then install the new HUB board on cabinet as shown below



Install all the cables into the new HUB board as shown below



Power on the cabinet

Receiving card

Power off the cabinet where the receiving card is in,

Take off the bad receiving card from the HUB board as shown below

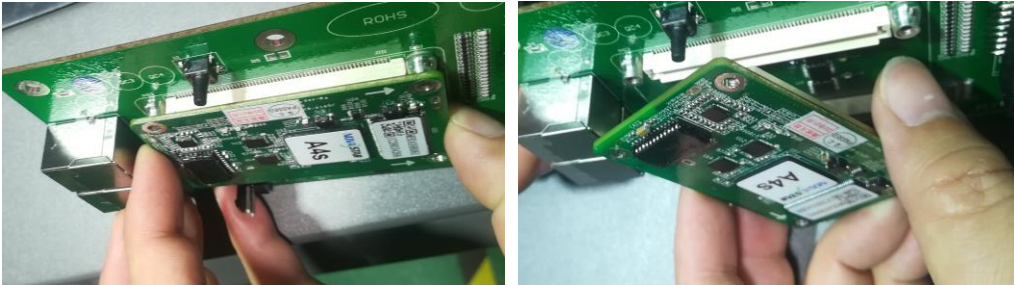

Bring a new receiving card and install it into the HUB board as shown below

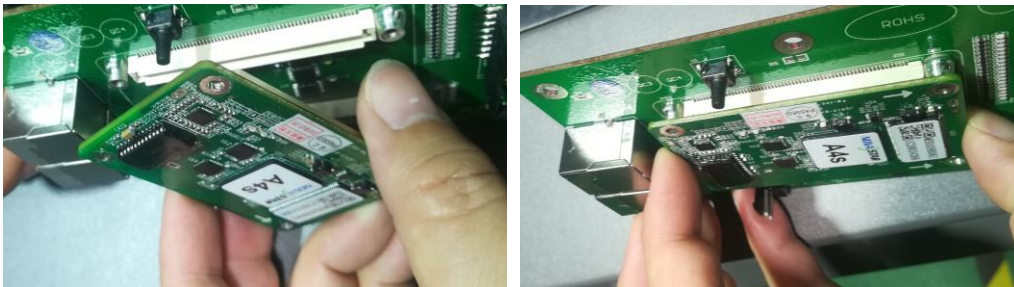

Power on the cabinet

Air switch

Power off the cabinet where the bad air switch is in,

Remove the cover for the air switch , take off all the cables on the bad air switch, and then remove the it from the cabinet as shown below

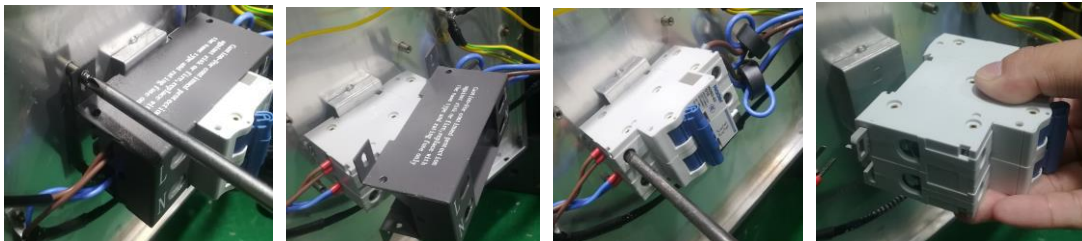

Bring a new air switch and install it into the cabinet, install all the cables into the new air switch, and then install the cover back on the cabinet as shown below

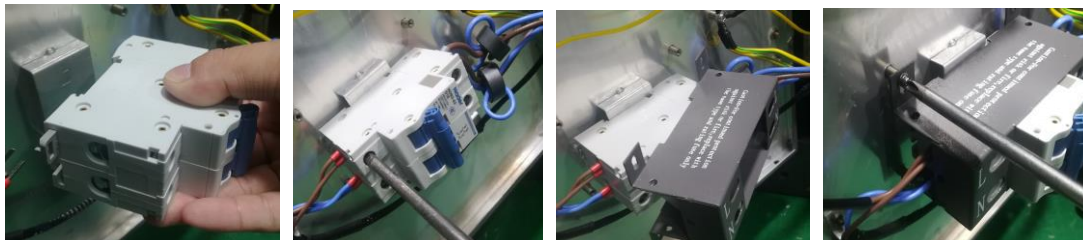

Power on the cabinet

AC input cable with connector

Power off the cabinet where the bad AC input cable is in

Remove the bad one from the cabinet

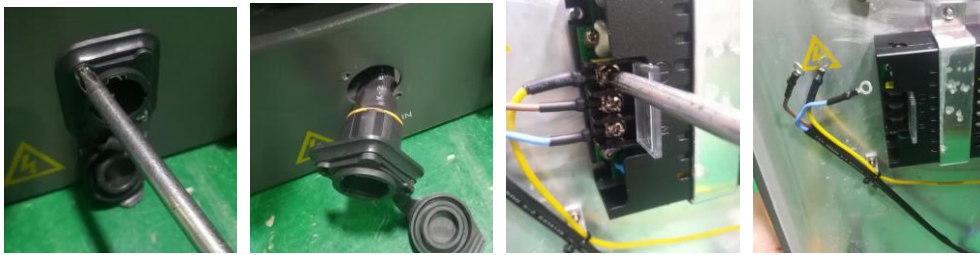

Install the new one.



Power on the cabinet

Signal input cable

Power off the cabinet where the bad Signal input cable is in

Remove the bad one from the cabinet



Install the new one



Power on the cabinet

Signal socket changing



Flat cable

Remove the bad one



Install the new one.



DC power cable

Power off the cabinet where the DC cable is,
Take off the bad one



Install the new one.

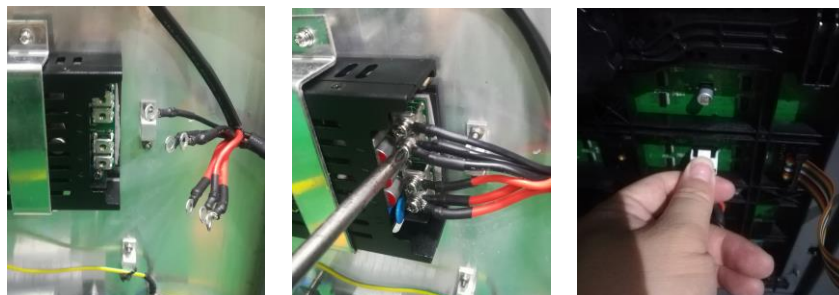

Turn on the cabinet.

11. Appendix

11.1 Responsibility for the Pay Service(Cost to Customers)

When the service is requested, in spite of in warranty, we may charge you for a visit from a service technician in the following cases.

Not a product defect

Cleaning of the product, Adjustment, Explanation, Re-installation and etc.

If a service technician gives instructions on how to use product or simply adjusts option without disassembling product.

If a defect is caused by external environmental factors(Internet, Antenna, wired signal, etc)

If a product is re-installed or devices are connected additionally after installing the purchased product for the first time.

If a product is re-installed to move to a different spot or to move to a different house.

If customer requests instructions on how to use because of another company`s product.

If customer requests instructions on how to use the network or another company`s program.

If customer requests software installation and setup for the product.

If a service technician removes/cleans dusts or foreign materials inside of the product.

If customer requests an installation additionally after purchasing a product through home shopping or online.

A product damage caused by customer`s fault

Product damage caused by customer`s mishandling or wrong repair.

If a product damage is caused by:

External impact or drop.

Use of supplier or separately sold product unspecified by Samsung.

Repair from a person besides an engineer of outsourcing service company or partner of Samsung Electronics Co.Ltd.

Remodeling or repairing the product by customer.

Using it with incorrect voltage or non-authorized electrical connections.

Not following the “cautions” in User manual.

Others

If product fails by natural disaster.(lighting, fire, earthquake, flood damage, etc)

If consumable components are used up.(Battery, Toner, Fluorescent lights, Head, Vibrator, Lamp, Filter, Ribbon, etc)

-If customer requests a service in case the product has no defect, service fee may be charged. So please read User Manual first.

11.2 Recycle Mark



This marking on the product, accessories or literature indicates that the product and its electronic accessories (e.g. power supply, cable, USB...) should not be disposed of with other household waste at the end of their working life. To prevent possible harm to the environment or human health from uncontrolled waste disposal, please separate these items from other types of waste and recycle them responsibly to promote the sustainable reuse of material resources.

